





MOLTO LUCE®

LIGHT & STYLIS 18|19

**EINBAULEUCHTEN INNEN / RECESSED INDOOR**

	AGON SQUARE/ROUND	004-005
	CLAERO	010-011
	COVER/DITTO	012-013
	ELIX / ELIX MINI	020-021
	LOOK SMAL/BIG	006-007
	MOBILIS 250/400	018-019
	MOON ROUND	032-033
	MOON SQUARE	030-031
	ODIN BIG	008-009
	PONTOS SQUARE/ROUND	014-015
	QANA / QANA 2	026-027
	SUNRAY	028-029
	TIA RECESSED	022-023
	VINOS SQUARE / ROUND	016-017
	VISIBLE II HV	024-025
	WINDOW I/II / PAN	034-035

**EINBAULEUCHTEN AUSSEN / RECESSED OUTDOOR**

	CHICCO SQUARE/ROUND	040-041
	CITY Z / CIRCINO	038-039
	IVY SQUARE/ROUND	036-037

**AUFBAULEUCHTEN INNEN / SURFACE INDOOR**

	AEON SQUARE/ROUND	044-045
	ALICA	072-073
	ARCA	076-077
	ARIK SHORT/LONG / CARMI AC	048-049
	BO SINGLE/DOUBLE	064-065
	BROOK SQUARE/ROUND AC	042-043
	CEN	062-063
	CLARUS / BENTY	066-067
	DENY R/E	080-081
	TIA AC / JOLENE	050-051
	MAGIS / MAGIS DOUBLE	054-055
	MAGIS MINI / MAGIS MINI DOUBLE	056-057
	MISSOR I/II	060-061
	NEONA / NIA	078-079
	NOEL AC	058-059
	NOVEL	070-071
	POLUS / UP AC	046-047
	QANA BOX I / II HV	052-053
	TAKE	074-075
	TALOS / OBLIQUUS	068-069

## AUFBAULEUCHTEN AUSSEN / SURFACE OUTDOOR

	AVA / PIATTA	096-097
	BEN SQUARE/ROUND	094-095
	FYNN C/O AC	106-107
	HARK AC / FORIS	114-115
	JAKE / ZAHRA	098-099
	JIB / VIDERI	112-113
	KATHA I	090-091
	LED FLOODLIGHTS	110-111
	NELL WALL	100-101
	NEXT	088-089
	SKYE	092-093
	TUBE / TURN UP/DOWN	102-103
	TURN II	108-109
	ZEON W	104-105

## HÄNGELEUCHTEN / PENDANTS

	AMEA 200/400/600	082-083
	ATYS / GILO	084-085
	MILO	086-087



















## POLLERLEUCHTEN AUSSEN / POLLARD OUTDOOR

	CITI SHORT/LONG	120-121
	GAIA	122-123
	MENDO / FYNN CP AC	116-117
	YARA FLAT / ZEON P	118-119

## ZUBEHÖR / COMPONENTS

	LED CONVERTER	120-123
--	---------------	---------

## LEGENDE / LEGEND

	DECKENAUSSCHNITT / CEILING CUTOUT / TAGLIO SOFFITTO
	EINBAUTIEFE / INSTALATION DEPTH / INSTALLAZIONE FONDO
	SCHWENKBAR / PIVOTING / ORIENTABILE
	DREHBAR / ROTATABLE / GIRAVOLE
	WEISS / WHITE / BIANCO
	GRAU / GREY / GRIGIO
	SILBER / SILVER / ARGENTO
	CHROM / CHROME / CROMO
	ANTHRAZIT / ANTHRACITE / ANTRACITE
	ALU GEBÜRSTET / ALU BRUSHED / ALLUM. SPAZZOLATO
	SCHWARZ / BLACK / NERO
	GOLD / GOLD / ORO
	LED 2700K
	LED 3000K
	LED 4000K
	AUSSTRAHLWINKEL / BEAM ANGLE / FASCIO LUMINOSO
	SCHUTZKL. I / PROTECTION CL. I / CL. PROTEZIONE I
	SCHUTZKL. II / PROTECTION CL. II / CL. PROTEZIONE II
	SCHUTZKL. III / PROTECTION CL. III / CL. DI PROTEZIONE III
<b>IP20</b>	INNENBEREICHE / INDOOR USING / UTILIZZO INTERNO
<b>IP44</b>	FEUCHTRAUMBER. / WET ROOM USING / AMBIENTE UMIDO
<b>IP54</b>	AUSSENBEREICHE / OUTDOOR USING / UTIL. ESTERNO
<b>IP65</b>	AUSSENBEREICHE / OUTDOOR USING / UTIL. ESTERNO



Einbaustrahler, Kühlkörper Aluminiumdruckguss gebürstet oder pulverbeschichtet, quadratisch oder rund, schwenkbar 30°, exkl. Konverter

Recessed spotlight, heat sink in die-cast aluminium, brushed or powder-coated, square or round, 30° tilting, excl. converter

Faretto ad incasso, dissipatore di calore in alluminio pressofuso, spazzolato o verniciato a polvere, quadrato o rotondo, 30° orientabile, converter non incluso

**W2** = LED 2700K  
**W3** = LED 3000K

LT: 25000h

**A++** - **A**

IP20  

### AGON SQUARE LED

LED 5W · 250mA · CRI >80

305-0050680202705	<b>W</b> <b>W2</b> <b>20°</b>	550lm
305-0050680402705	<b>W</b> <b>W2</b> <b>40°</b>	550lm
305-0050680202706	<b>S</b> <b>W2</b> <b>20°</b>	550lm
305-0050680402706	<b>S</b> <b>W2</b> <b>40°</b>	550lm
305-0050680202715	<b>W</b> <b>W3</b> <b>20°</b>	550lm
305-0050680402715	<b>W</b> <b>W3</b> <b>40°</b>	550lm
305-0050680203005	<b>W</b> <b>W3</b> <b>20°</b>	600lm
305-0050680403005	<b>W</b> <b>W3</b> <b>40°</b>	600lm
305-0050680203006	<b>S</b> <b>W3</b> <b>20°</b>	600lm
305-0050680403006	<b>S</b> <b>W3</b> <b>40°</b>	600lm
305-0050680203015	<b>W</b> <b>W3</b> <b>20°</b>	600lm
305-0050680403015	<b>W</b> <b>W3</b> <b>40°</b>	600lm



### AGON ROUND LED

LED 5W · 250mA · CRI >80

305-0040680202705	<b>W</b> <b>W2</b> <b>20°</b>	550lm
305-0040680402705	<b>W</b> <b>W2</b> <b>40°</b>	550lm
305-0040680202706	<b>S</b> <b>W2</b> <b>20°</b>	550lm
305-0040680402706	<b>S</b> <b>W2</b> <b>40°</b>	550lm
305-0040680202715	<b>W</b> <b>W3</b> <b>20°</b>	550lm
305-0040680402715	<b>W</b> <b>W3</b> <b>40°</b>	550lm
305-0040680203005	<b>W</b> <b>W3</b> <b>20°</b>	600lm
305-0040680403005	<b>W</b> <b>W3</b> <b>40°</b>	600lm
305-0040680203006	<b>S</b> <b>W3</b> <b>20°</b>	600lm
305-0040680403006	<b>S</b> <b>W3</b> <b>40°</b>	600lm
305-0040680203015	<b>W</b> <b>W3</b> <b>20°</b>	600lm
305-0040680403015	<b>W</b> <b>W3</b> <b>40°</b>	600lm

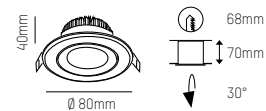

### LED CONVERTER AGON

Info: page 120-123

24-122201	<b>W</b>	250mA · schaltbar / switchable
24-123399	<b>W</b>	250mA · 1 - 10V / push dimm.
24-123403	<b>W</b>	250mA · DALI dimm.





Einbaustrahler, Aluminiumdruckguss, weiß pulverbeschichtet, rund, starr, mit zurückversetzter Lichtquelle, exkl. Konverter

Recessed spotlight, die-cast aluminium, white powder-coated, round, fixed, with recessed light source, excl. converter

Faretto ad incasso in alluminio pressofuso, verniciato a polvere in bianco, rotondo, fisso, lampadina retrocessa, converter non incluso

**W3** = LED 3000K



LT: 25000h

**A++ - A**

IP20  

### LOOK SMALL ROUND LED

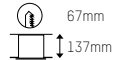
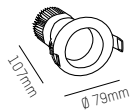

LED 7W · 350mA · CRI >90

472-291010wr    535lm



### LOOK BIG ROUND LED

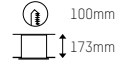
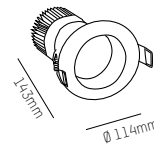

LED 10,8W · 350mA · CRI >90

472-0321090303005    795lm



### LED CONVERTER LOOK SMALL/BIG

Info: page 120-123

24-122201  350mA · schaltbar / switchable  
 24-123400  250mA · 1 - 10V / push dimm.  
 24-123403  350mA · 1 - 10V / push / DALI dimm.



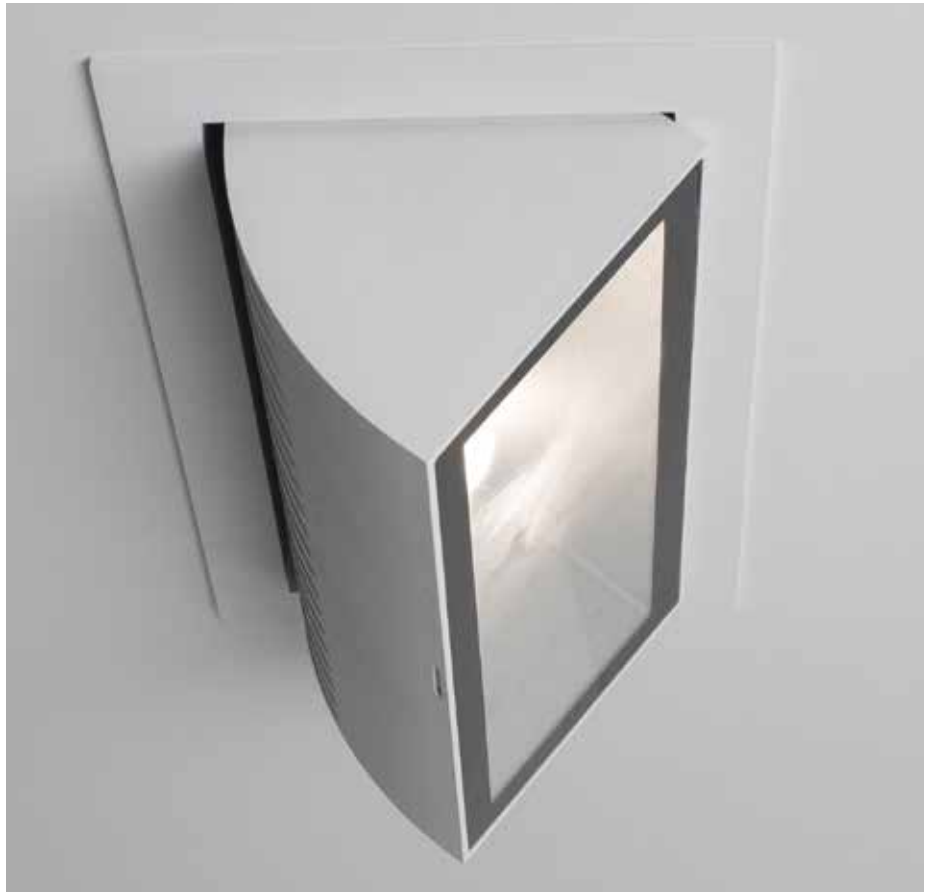

Einbaustrahler, Aluminiumdruckguss, weiß matt pulverbeschichtet, 90° schwenkbar, Aluminiumreflektor, 82° Ausstrahlwinkel, inkl. Schutzglas klar, exkl. Konverter



Recessed spotlight, die-cast aluminium, white matt powder-coated, 90° tilting, aluminium reflector, 82° beam angle, incl. protection glass

Faretto ad incasso in alluminio pressofuso, verniciato a polvere in bianco opaco, 90° girevole, riflettore in alluminio, fascio luminoso 82°, vetro di sicurezza trasparente incluso, converter non incluso

**W3** = LED 3000K



LT: 25000h

**A++ - A**

**IP 44**  

## ODIN BIG LED

LED 38W · 1050mA · CRI >95

**365-1001**    2280lm

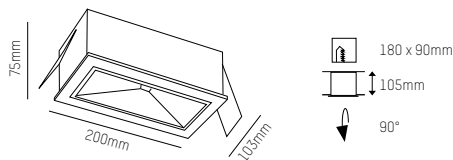

## LED CONVERTER ODIN BIG

Info: page 120-123

**24-122204**  1050mA · schaltbar / switchable

**24-122413**  1050mA · 1 - 10V / push / DALI dimm.



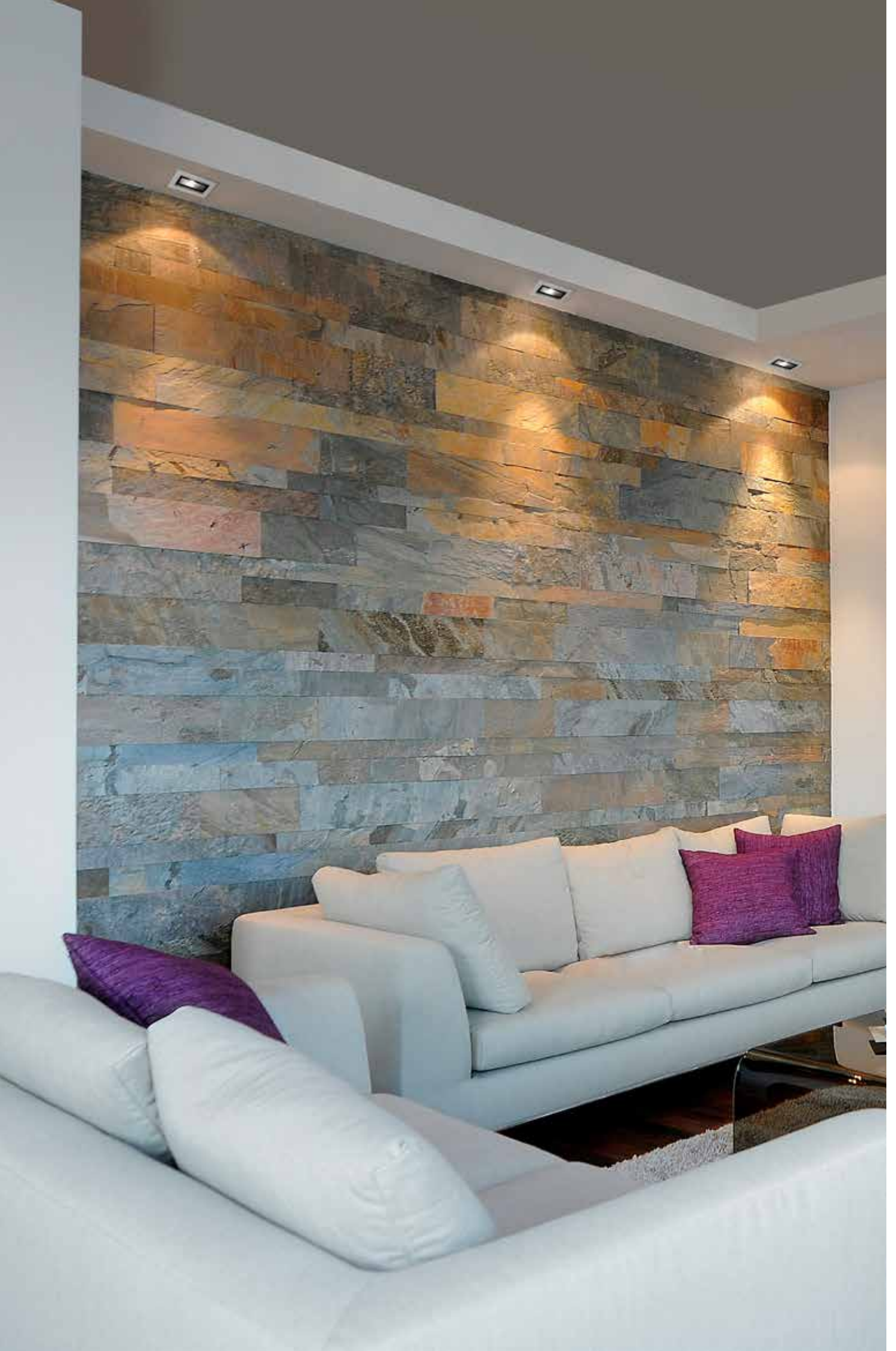



Einbaustrahler, Aluminiumdruckguss, weiß matt pulverbeschichtet oder schwarz lackiert, quadratisch, schwenkbar 30°, exkl. Konverter

Recessed spotlight, die-cast aluminium, white matt powder-coated or black painted, square, tilting 30°, excl. converter

Faretto ad incasso in alluminio pressofuso, verniciato a polvere in bianco o nero, quadrato, 30° orientabile, converter non incluso

**W3** = LED 3000K

LT: 25000h

**A++** - **A**

IP20  

### CLAERO LED

LED 15W · 700mA · CRI >90

**365-0061590243005**



905lm

**365-0061590243006**



905lm

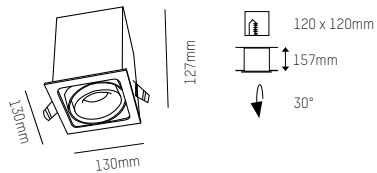

### LED CONVERTER CLAERO

Info: page 120-123

**24-122201**



700mA · schaltbar / switchable

**24-123400**



700mA · 1 - 10V / push dimm.

**24-123403**



700mA · DALI dimm.





Einbaustrahler, Aluminiumdruckguss, weiß oder silber pulverbeschichtet, quadratisch oder rund, sandgestrahltes Schutzglas, exkl. Konverter, EB-Gehäuse und EB-Rahmen separat ordern

Recessed spotlight, die-cast aluminium, white or silver powder-coated, square or round, frosted safety glass, excl. converter, recessed housing and recessed frames to be ordered separately

Faretto ad incasso in alluminio pressofuso, verniciato a polvere in bianco oppure argento, quadrato o rotondo, vetro di sicurezza satinato incluso, converter non incluso, scatola ad incasso e relativo coperchio preforato da ordinare separatamente

**W3** = LED 3000K

LT: 25000h

**A++ - A**

**IP 44**

### COVER LED

LED 6W · 140mA · CRI >80

**305-6845w** **W W3** 435lm  
**305-6845s** **S W3** 435lm

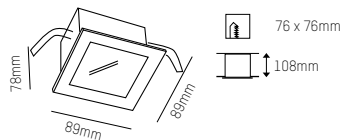

### DITTO LED

LED 6W · 140mA · CRI >80

**305-6846w** **W W3** 415lm  
**305-6846s** **S W3** 415lm

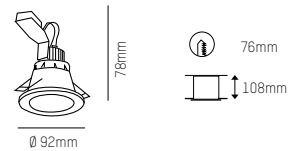

### EINPUTZRAHMEN / PLASTERING FRAME

**332-1302** for Cover

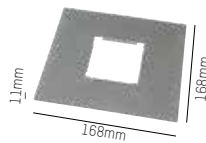

### EINPUTZRAHMEN / PLASTERING FRAME

**332-1402** for Ditto

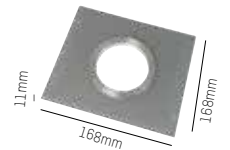

### EINBAUBOX / RECESSED HOUSING

**332-1001** for Cover

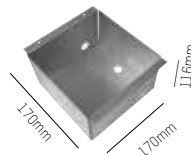

### EINBAUBOX / RECESSED HOUSING

**332-1001** for Ditto

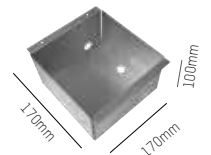

### LED CONVERTER COVER/DITTO

Info: page 120-123

**24-122203** **W** 140mA · schaltbar / switchable  
**24-123401** **W** 140mA · 1 - 10V / push dimm.  
**24-123395** **W** 140mA · DALI dimm.





Einbaustrahler, Aluminiumdruckguss, weiß, schwarz oder silber pulverbeschichtet, quadratisch oder rund, schwenkbar 25°, mit zurückversetzter Lichtquelle, exkl. Konverter

Recessed spotlight, die- cast aluminium, white, black or silver powder-coated, square or round, tilting 25°, with recessed light source, excl. converter

Faretto ad incasso in alluminio pressofuso, verniciato a polvere in bianco, nero oppure argento, quadrato o rotondo, 25° orientabile, lampadina retrocessa, converter escluso

**W2** = LED 2700K  
**W3** = LED 3000K

LT: 25000h

**A++ - A**

**IP 44**

### PONTOS SQUARE LED

LED 10W · 250mA · CRI >80

305-621524w27k	<b>W</b> <b>W2</b> <b>24°</b>	732lm
305-621524b27k	<b>S</b> <b>W2</b> <b>24°</b>	732lm
305-621524s27k	<b>S</b> <b>W2</b> <b>24°</b>	732lm

305-621524w	<b>W</b> <b>W3</b> <b>24°</b>	770lm
305-621524b	<b>S</b> <b>W3</b> <b>24°</b>	770lm
305-621524s	<b>S</b> <b>W3</b> <b>24°</b>	770lm

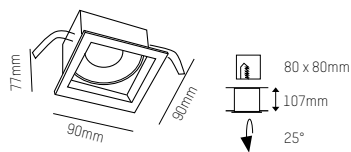

### PONTOS ROUND LED

LED 10W · 250mA · CRI >80

305-602024w27k	<b>W</b> <b>W2</b> <b>24°</b>	644lm
305-602024b27k	<b>S</b> <b>W2</b> <b>24°</b>	644lm
305-602024s27k	<b>S</b> <b>W2</b> <b>24°</b>	644lm

305-602024w	<b>W</b> <b>W3</b> <b>24°</b>	695lm
305-602024b	<b>S</b> <b>W3</b> <b>24°</b>	695lm
305-602024s	<b>S</b> <b>W3</b> <b>24°</b>	695lm

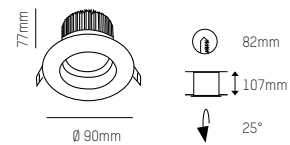

### LED CONVERTER PONTOS

Info: page 120-123

24-122201	<b>W</b>	250mA · schaltbar / switchable
24-123399	<b>W</b>	250mA · 1-10V / push dimm.
24-123403	<b>W</b>	250mA · DALI dimm.





Einbaustrahler, Aluminiumdruckguss, weiß oder schwarz matt pulverbeschichtet, oder gold lackiert (nur bei Vinos round), rahmenlos, quadratisch oder rund, mit zurückversetzter Lichtquelle, 38° Ausstrahlwinkel, exkl. Konverter

Recessed spotlight, die-cast aluminium, white or black matt powder-coated, or gold painted (only for Vinos round), trimless, square or round, with recessed light source, 38° beam angle, excl. converter

Faretto ad incasso in alluminio pressofuso, verniciato a polvere in bianco o nero, oppure laccato in oro (solo per Vinos round), senza cornice, quadrato o rotondo, lampadina retrocessa, fascio luminoso 38°, converter escluso

**W2** = LED 2700K  
**W3** = LED 3000K

LT: 25000h

**A++** - **A**

IP20  

### NEW! VINOS SQUARE LED

LED 13W · 350mA · CRI >95

<b>365-0141390382705</b>	<b>W</b> <b>W2</b> <b>38°</b>	950lm
<b>365-0141390382706</b>	<b>S</b> <b>W2</b> <b>38°</b>	845lm
<b>365-0141390383005</b>	<b>W</b> <b>W3</b> <b>38°</b>	1050lm
<b>365-0141390383006</b>	<b>S</b> <b>W3</b> <b>38°</b>	1005lm

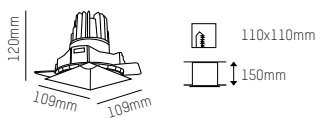

### VINOS ROUND LED

LED 13W · 350mA · CRI >95

<b>365-1005132738</b>	<b>W</b> <b>W2</b> <b>38°</b>	850lm
<b>365-1006132738</b>	<b>S</b> <b>W2</b> <b>38°</b>	870lm
<b>365-1003132738</b>	<b>G</b> <b>W2</b> <b>38°</b>	870lm
<b>365-100513338</b>	<b>W</b> <b>W3</b> <b>38°</b>	980lm
<b>365-100613338</b>	<b>S</b> <b>W3</b> <b>38°</b>	915lm
<b>365-100313338</b>	<b>G</b> <b>W3</b> <b>38°</b>	940lm

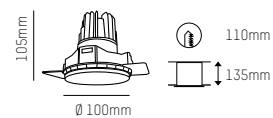

### LED CONVERTER VINOS

Info: page 120-123

<b>24-122201</b>	<b>W</b>	350mA · schaltbar / switchable
<b>24-123400</b>	<b>W</b>	350mA · 1 - 10V / push dimm.
<b>24-123403</b>	<b>W</b>	350mA · DALI dimm.







Einbaustrahler, Aluminiumdruckguss, weiß oder schwarz Feinstruktur pulverbeschichtet, Dekorring aus Kunststoff schwarz, zylindrisch, Leuchtenkopf 30° schwenk- und 355° drehbar, ausziehbar (Einbautiefe beachten), 33° Ausstrahlwinkel, exkl. Konverter

Recessed spotlight, die-cast aluminium, white or black powder-coated with fine textured paint, decoration ring made of black synthetic, cylindrical, spotlight head 30° tilting and 355° swiveling, extendable (pay attention to mounting depth) excl. converter

Faretto ad incasso in alluminio pressofuso, verniciato a polvere in bianco o nero, anello decorativo in sintetico nero, cilindrico, testa 30° orientabile e 355° girevole, allungabile (prestare attenzione alla profondità dell'incasso), fascio luminoso 33°, converter non incluso

**W3** = LED 3000K

LT: 25000h



IP20

### MOBILIS 250 LED

LED 7,8W · 700mA · CRI >80

276-10083080wb 307lm  
 276-10083080bb 307lm

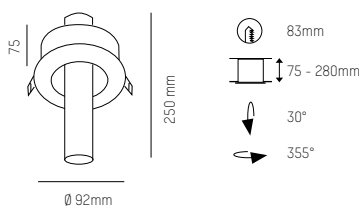

### MOBILIS 400 LED

LED 7,8W · 700mA · CRI >80

276-10073080wb 307lm  
 276-10073080bb 307lm

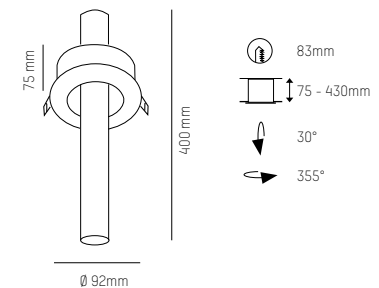

### LED CONVERTER MOBILIS

Info: page 120-123

24-122201 700mA · schaltbar / switchable  
 24-123400 700mA · 1 - 10V / push dimm.  
 24-123403 700mA · DALI dimm.





Dekorring innen standard schwarz  
Decor ring inside standard black



#### ELIX

Einbaustrahler, Aluminiumdruckguss, matt Feinstruktur pulverbeschichtet, Dekorring aus Kunststoff schwarz, Stahlerkopf 45° schwenk- und 355° drehbar, 33° Ausstrahlwinkel, exkl. Konverter

Recessed spotlight, die-cast aluminium, matt powder-coated with fine textured paint, decoration ring made of black synthetic, spotlight head 90° tilting and 350° swiveling, 34° beam angle, excl. converter

Faretto ad incasso in alluminio pressofuso, verniciato a polvere opaca, anello decorativo in sintetico nero, testa 45° orientabile e 355° girevole, fascio luminoso 33°, converter non incluso

#### ELIX MINI

Einbaustrahler, Aluminiumdruckguss, matt Feinstruktur pulverbeschichtet, Dekorring aus Kunststoff schwarz, Stahlerkopf 90° schwenk- und 350° drehbar, 34° Ausstrahlwinkel, exkl. Konverter

Recessed spotlight, die-cast aluminium, matt powder-coated with textured paint, decoration ring made of black synthetic, spotlight head 90° tilting and 350° swiveling, 34° beam angle, excl. converter

Faretto ad incasso in alluminio pressofuso, verniciato a polvere opaca, anello decorativo in sintetico nero, testa 90° orientabile e 350° girevole, fascio luminoso 34°, converter non incluso

W2 = LED 2700K  
W3 = LED 3000K

LT: 25000h



IP 20

#### ELIX LED

LED 9,2W · 500mA · CRI >90

276-0010990332756	W W2	33°	550lm
276-0010990332706	S W2	33°	550lm
276-0010990333056	W W3	33°	650lm
276-0010990333006	S W3	33°	650lm

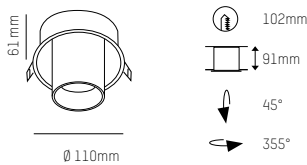

#### NEW! ELIX MINI LED

LED 6,2W · 350mA · CRI >90

276-0130690342756	W W2	34°	330lm
276-0130690342706	S W2	34°	330lm
276-0130690343056	W W3	34°	340lm
276-0130690343006	S W3	34°	340lm

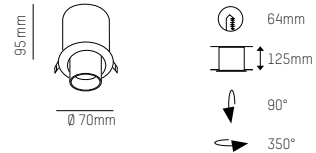

#### DEKORRING/DECOR RING ELIX

innenliegend, separat ordern / inside, order separately

276-7001	W	
276-7000	G	

Ø 60mm

#### DEKORRING/DECOR RING ELIX MINI

innenliegend, separat ordern / inside, order separately

276-7003	W	
276-7002	G	

Ø 37mm

#### WABENRASTER/HONEY COMB LOUVRE ELIX

werkzeuglos montierbar / mounting without tools

276-1002	S	
----------	---	--

#### LED CONVERTER ELIX + ELIX MINI

Info: page 120-123

24-122201	W	350/500mA · schaltbar / switchable
24-123400	W	350/500mA · 1 - 10V / push dimm.
24-123403	W	350/500mA · DALI dimm.





Einbaustrahler aus Aluminiumdruckguss, feinstruktur matt pulverbeschichtet, Cover opal, starr, AC-LED, zurückversetzte Lichtquelle, hochwertiger vacuumbedampfter Aluminiumreflektor

Recessed spotlight made of die-cast aluminium, matt powder-coated with fine textured paint, opal cover, AC-LED, recessed light source, high quality vacuum deposited aluminium reflector

Faretto ad incasso in alluminio pressofuso, verniciato a polvere opaca, copertura opale, fisso, AC-LED, lampadina retrocessa, riflettore con deposizione di alluminio purissimo

W2 = LED 2700K  
W3 = LED 3000K

LT: 25000h

A++ - A

IP20

### NEW! TIA RECESSED AC-LED

SYS 8W · 230V · CRI >90

472-0520890382707 W0 W2 138° 460lm

472-0520890383007 W0 W3 138° 500lm

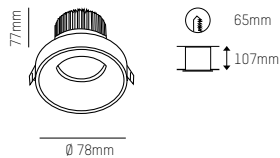





Einbaustrahler, Aluminiumdruckguss, weiß, schwarz oder silber pulverbeschichtet, quadratisch, schwenkbar 32°, mit zurückversetzter Lichtquelle, EB-Gehäuse und EB-Rahmen separat ordern

Recessed spotlight, die-cast aluminium, white, black or silver powder-coated, square, tilting 32°, with recessed light source, recessed housing and recessed frames to be ordered separately

Faretto ad incasso in alluminio pressofuso, verniciato a polvere in bianco, nero oppure argento, quadrato, 32° girevole, lampadina retrocessa, scatola ad incasso e relativo coperchio da ordinare separatamente

**A++** - **D**

IP20  

### VISIBLE II HV

QPAR16 · GU10 · 230V · max. 50W or LED Retrofit · GU10

305-1440w

**W**

305-1440s

**S**

305-1440b

**S**

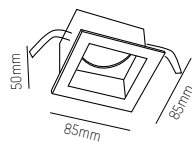

 74 x 72mm

 80mm

 32°

### EINPUTZRAHMEN / PLASTERING FLAME

332-1202 for Visible II

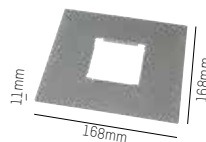

### EINBAUBOX / RECESSED HOUSING

332-1001 for Visible II

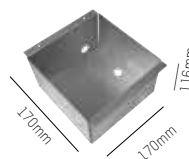







Einbauleuchten Kardanisch, Aluminium gefräst, lackiert, weiß oder schwarz pulverbeschichtet, gefräßt, 350° dreh- / 30° schwenkbar

Gimbal downlight, milled aluminium, painted, white or black powder-coated, 350° swiveling and 30° tilting



Faro da incasso in alluminio fresato, laccato, verniciato a polvere in bianco o nero, 350° orientabile e 30° girevole

**A++ - D**

IP20  

### NEW! QANA I

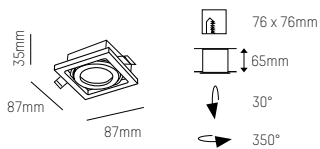

QPAR16 · GU10 · 230V · max. 50W or LED Retrofit · GU10

- 472-25903405hv 
- 472-25903406hv 
- 472-259034hv 



### NEW! QANA II

2 x QPAR16 · GU10 · 230V · max. 50W or LED Retrofit · GU10

- 472-25903505hv 
- 472-25903506hv 
- 472-259035hv 

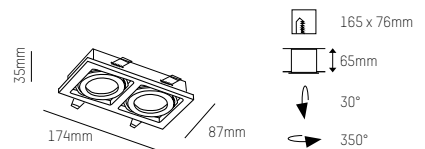





Einbaustrahler, Aluminiumdruckguss, weiß pulverbeschichtet Feinstruktur, passiv gekühlt, rund, starr, Schutzglas, exkl. Konverter

Recessed downlight, aluminium die-cast, white powder-coated with fine textured paint, passively cooling, round, protection glass, excl. converter

Faretto da incasso in alluminio pressofuso, verniciato a polvere in bianco, dissipazione passiva, rotondo, fisso, vetro di sicurezza incluso, converter non incluso

**W3** = LED 3000K

LT: 25000h

**A++ - A**

**IP 44**  

### SUNRAY I LED

LED 9W · 250mA · CRI >80

797-0001180303005 **W** **W3**  930lm

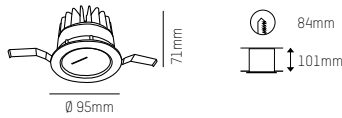

### SUNRAY II LED

LED 18W · 500mA · CRI >80

797-0011880373005 **W** **W3**  1850lm

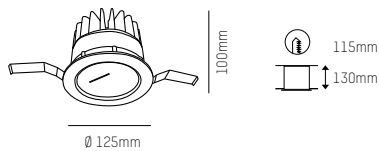

### LED CONVERTER SUNRAY I / II

Info: page 120-123

24-122201	<b>W</b>	250 / 500mA · schaltbar / switchable
24-123399	<b>W</b>	250mA · 1 - 10V / push dimm.
24-123400	<b>W</b>	500mA · 1 - 10V / push dimm.
24-123403	<b>W</b>	250 / 500mA · 1 - 10V / DALI dimm.

### SUNRAY III LED

LED 27W · 700mA · CRI >80

797-0022780453005 **W** **W3**  2510lm

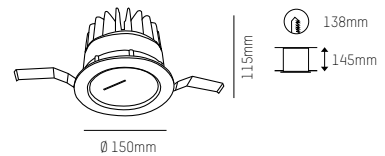

### LED CONVERTER SUNRAY III

Info: page 120-123

24-122204	<b>W</b>	700mA · schaltbar / switchable
24-122413	<b>W</b>	700mA · 1 - 10V / Push / DALI dimm.

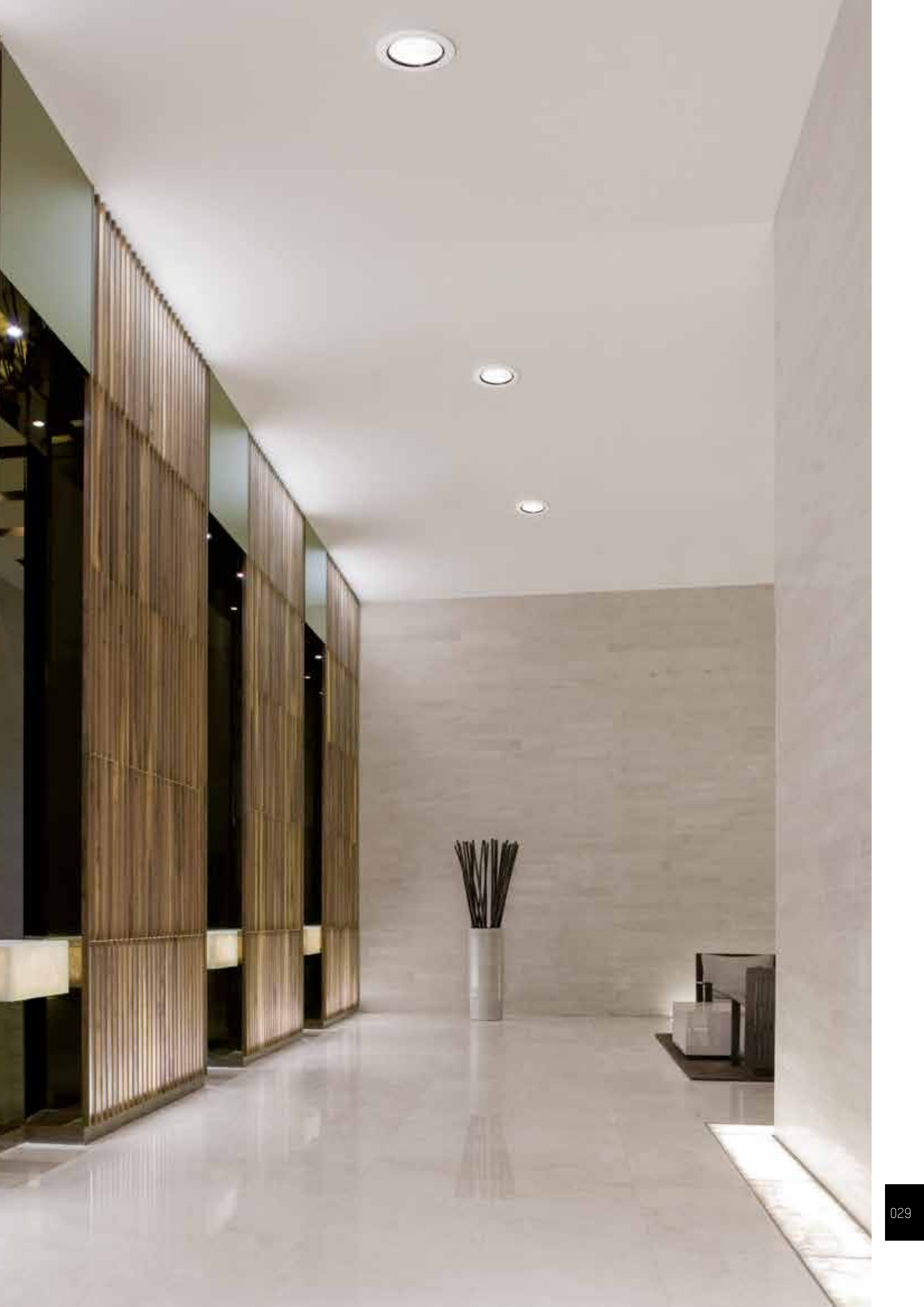



Einbauleuchte, Aluminium, weiß matt lackiert, passiv gekühlt, quadratisch, sehr homogene Ausleuchtung, opaler Diffusor, 120° Ausstrahlwinkel, extrem flach, exkl. Konverter, Achtung: ca. 30mm Platz für Konverter einplanen

Recessed luminaire, aluminium, white matt painted, passive cooling, square, very homogeneous illumination, opal diffuser, 120° beam angle, extremely flat, excl. converter. Attention: approx. 30 mm space needed for converter

Faro da incasso in alluminio, laccatura opaca bianca, dissipazione passiva, quadrato, illuminazione molto omogenea, diffusore opale, fascio luminoso 120°, piatto, converter escluso, Attenzione: considerare circa 30 mm di spazio per il montaggio del converter

**W3** = LED 3000K  
**W4** = LED 4000K

LT: 25000h

**A++** - **A**

**IP 44**



### MOON SQUARE 110 LED

LED 6W · 250mA · CRI >80

**392-0030680003005** 620lm  
**392-0030680004005** 670lm



### MOON SQUARE 180 LED

LED 12W · 450mA · CRI >80

**392-0041280003005** 1215lm  
**392-0041280004005** 1335lm



### MOON SQUARE 300 LED

LED 18W · 700mA · CRI >80

**392-0051880003005** 2300lm  
**392-0051880004005** 2375lm

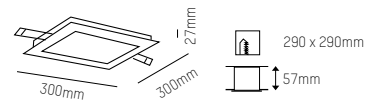

### AUFBAUGEHÄUSE / SURFACE HOUSING

separat ordern / order separately



for

**643-q110agw** **MOON 110** 113,5 x 113,5 x 46mm  
**643-q180agw** **MOON 180** 184 x 184 x 46mm  
**643-q300agw** **MOON 300** 305 x 305 x 46mm

### LED CONVERTER MOON 110

Info: page 120-123

**24-122812** 250mA · für Aufbau/for surface  
**24-122201** 250mA · schaltbar / switchable  
**24-123399** 250mA · 1 - 10V / push dimm.  
**24-123403** 250mA · DALI dimm.

### LED CONVERTER MOON 180 / 300

Info: page 120-123

**24-122201** 450 / 700mA · schaltbar / switchable  
**24-123400** 450 / 700mA · 1 - 10V / push dimm.  
**24-123403** 450 / 700mA · DALI dimm.

VINOTHEK  
SEMINARRAUM

BAR/KINO  
BILLARD

PLAY LOUNGE  
KEGELBAHN



Einbauleuchte, Aluminium, weiß matt lackiert, passiv gekühlt, rund, sehr homogene Ausleuchtung, opaler Diffusor, 120° Ausstrahlwinkel, extrem flach, exkl. Konverter, Achtung: ca. 30mm Platz für Konverter einplanen

Recessed luminaire, aluminium, white matt painted, passive cooling, round, very homogeneous illumination, opal diffuser, 120° beam angle, extremely flat, excl. converter. Attention: approx. 30 mm space needed for converter

Faro da incasso in alluminio, laccatura opaca bianca, dissipazione passiva, rotondo, illuminazione molto omogenea, diffusore opale, fascio luminoso 120°, piatto, converter non incluso, Attenzione: considerare circa 30mm di spazio per il montaggio del converter

**W3** = LED 3000K  
**W4** = LED 4000K

LT: 25000h

**A++** - **A**

IP 44



### MOON ROUND 110 LED

LED 6W · 250mA · CRI >80

**392-0000680003005** 650lm  
**392-0000680004005** 740lm

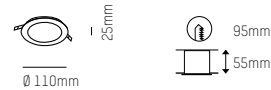

### MOON ROUND 180 LED

LED 12W · 450mA · CRI >80

**392-0011280003005** 1420lm  
**392-0011280004005** 1550lm

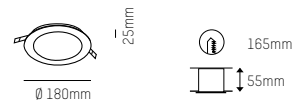

### MOON ROUND 300 LED

LED 18W · 700mA · CRI >80

**392-0021880003005** 2055lm  
**392-0021880004005** 2085lm

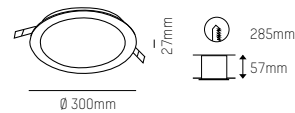

### AUFBAUGEHÄUSE / SURFACE HOUSING

separat ordern / order separately

for

**643-j110agw** **MOON 110** Ø 112 x 46mm  
**643-j180agw** **MOON 180** Ø 182 x 46mm  
**643-j300agw** **MOON 300** Ø 303,5 x 46mm



### LED CONVERTER MOON 110

Info: page 120-123

**24-122812** 250mA · für Aufbau / for surface  
**24-122201** 250mA · schaltbar / switchable  
**24-123399** 250mA · 1 - 10V / push dimm.  
**24-123403** 250mA · DALI dimm.

### LED CONVERTER MOON 180 / 300

Info: page 120-123

**24-122201** 450 / 700mA · schaltbar / switchable  
**24-123400** 450 / 700mA · 1 - 10V / push dimm.  
**24-123403** 450 / 700mA · DALI dimm.







#### WINDOW II / WINDOW II

Wandeinbauleuchte, Aluminium eloxiert, quadratisch, symmetrisch oder asymmetrisch, inkl. Haltefedern für Hohlwandmontage, exkl. Konverter, Einbaubox separat ordern

Recessed wall luminaire, aluminium anodised, square, symmetrical or asymmetrical, incl. holding spring for cavity wall mounting, excl. converter, recessed box to be ordered separately

Lampada ad incasso a parete in alluminio anodizzato, quadrato, simmetrico oppure asimmetrico, molla per montaggio a controsoffitto inclusa, converter non incluso, scatola ad incasso da ordinare separatamente

#### PAN

Wandeinbauleuchte Aluminiumdruckguss, matt Feinstruktur pulverbeschichtet, asymmetrischer Lichtaustritt, Diffusor opal, exkl. Konverter, Einbaubox separat ordern

Recessed wall luminaire, die-cast aluminium, matt powder-coated with fine textured paint, asymmetrical light exit, opal diffuser, excl. converter, recessed box to be ordered separately

Lampada ad incasso a parete in alluminio pressofuso, verniciata a polvere opaca, fascio luminoso asimmetrico, diffusore opale, converter escluso, scatola ad incasso da ordinare separatamente

**W3** = LED 3000K

LT: 25000h



IP20

#### WINDOW I LED

LED 3W · 250mA · CRI >80

305-6801p 234lm

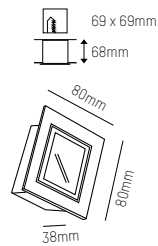

#### WINDOW II LED

LED 3W · 250mA · CRI >80

305-6800p 167lm

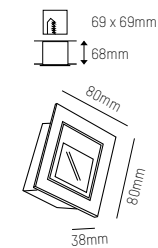

#### NEW! PAN LED

LED 3W · 250mA · CRI >80

305-0130380003005 155lm

305-0130380003004 155lm

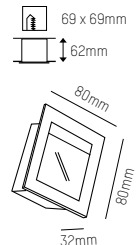

#### EINBAUBOX / RECESSED HOUSING

für WINDOW & PAN / for WINDOW & PAN  
separat ordern / order separately

305-5058

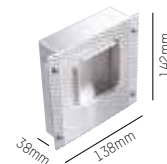

#### LED CONVERTER WINDOW & PAN

Info: page 120-123

24-122812 250mA · schaltbar / switchable





Einbaustrahler, Aluminiumdruckguss, Feinstruktur matt pulverbeschichtet, quadratisch oder rund, runder Deckenausschnitt, starr, mit zurückversetzter Lichtquelle, erhältlich in 2 Ausstrahlwinkeln, exkl. Konverter

Recessed spotlight, die-cast aluminium, matt powder-coated with fine textured paint, square or round, round ceiling cutout, fixed, with recessed light source, available in 2 beam angles, excl. converter

Faretto da incasso in alluminio pressofuso, verniciato a polvere opaca, quadrato e rotondo, taglio rotondo, fisso, lampadina retrocessa, disponibile in due diversi fasci luminosi, converter escluso

**W3** = LED 3000K













LT: 25000h

**A++** - **A**

**IP 54**  

### IVY SQUARE LED





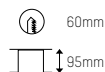
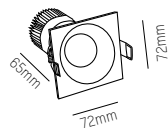







LED 7W · 200mA · CRI >90

<b>472-0270790203005</b>	  	660lm
<b>472-0270790403005</b>	  	650lm
<b>472-0270790203006</b>	  	650lm
<b>472-0270790403006</b>	  	530lm



### IVY ROUND LED

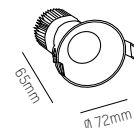

LED 7W · 200mA · CRI >90

<b>472-0260790203005</b>	  	700lm
<b>472-0260790403005</b>	  	670lm
<b>472-0260790203006</b>	  	535lm
<b>472-0260790403006</b>	  	620lm



### LED CONVERTER IVY

Info: page 120-123

<b>24-122360</b>		200mA · schaltbar / switchable
<b>24-123401</b>		200mA · 1 - 10V / push dimm.
<b>24-123395</b>		180mA · DALI dimm.





#### CITY Z

Einbaustrahler, Aluminium, Feinstruktur matt pulverbeschichtet, quadratisch, starr, inkl. klarem Schutzglas, 37° Ausstrahlwinkel, excl. Konverter

Recessed spotlight in aluminium, matt powder-coated with fine textured paint, square, fixed, incl. clear protection glass, 37° beam angle, excl. converter

Faretto ad incasso in alluminio, verniciato a polvere opaca, quadrato, fisso, vetro di sicurezza trasparente incluso, fascio luminoso 37°, escluso converter

#### CIRCINO

Einbaustrahler, Aluminiumdruckguss Feinstruktur matt pulverbeschichtet, starr, zurückversetzte Lichtquelle, 30° Ausstrahlwinkel, excl. Konverter

Recessed spotlight, die-cast aluminium, matt powder-coated with fine textured paint, fixed, recessed light source, 30° beam angle, excl. converter

Faretto ad incasso in alluminio pressofuso, verniciato a polvere opaca, fisso, lampadina retrocessa, fascio luminoso 30°, converter escluso

**W3** = LED 3000K

LT: 25000h

**A++** - **A**

**IP 54**

#### CITY Z LED

LED 12W · 350mA · CRI >80

**308-101512337ng1** 1220lm  
**308-101612337ng1** 1220lm

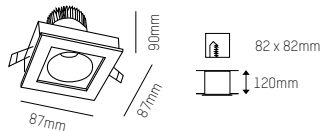

#### CIRCINO LED

LED 15W · 700mA · CRI >90

**365-0051590243005** 1555lm  
**365-0051590243006** 1555lm  
**365-0051590243014** 1555lm

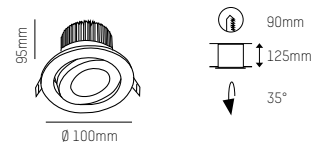

#### LED CONVERTER CITY Z

Info: page 120-123

**24-122201** 350mA · schaltbar / switchable  
**24-123400** 350mA · 1 - 10V / push dimm.  
**24-123403** 350mA · DALI dimm.

#### LED CONVERTER CIRCINO

Info: page 120-123

**24-122201** 700mA · schaltbar / switchable  
**24-123400** 700mA · 1 - 10V / push dimm.  
**24-123403** 700mA · DALI dimm.



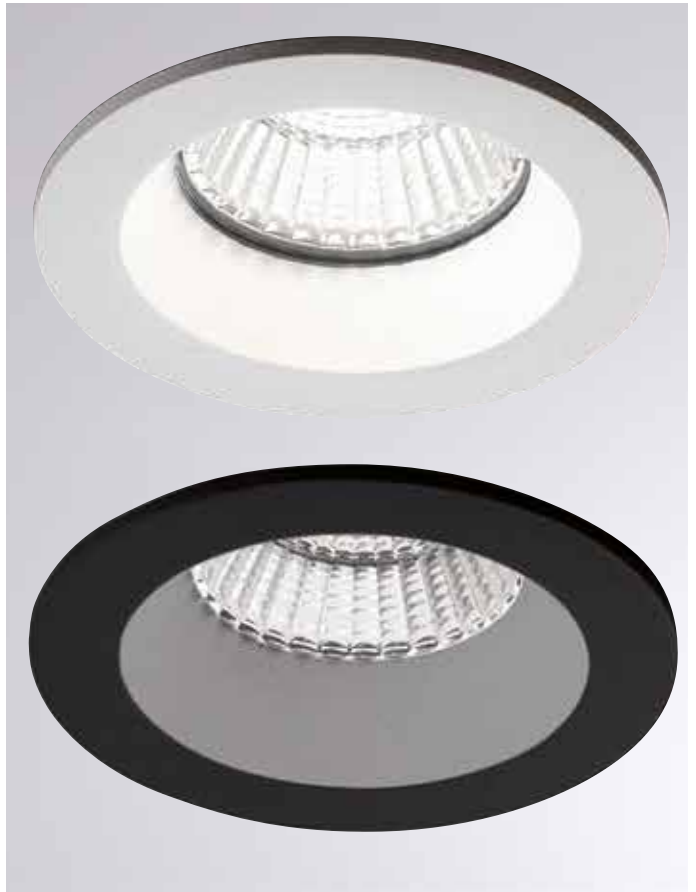

Einbaustrahler, Aluminiumdruckguss Feinstruktur matt pulverbeschichtet, starr, zurückversetzte Lichtquelle, 30° Ausstrahlwinkel, exkl. Konverter

Recessed spotlight, die-cast aluminium, matt powder-coated with fine textured paint, fixed, recessed light source, 30° beam angle, excl. converter

Faretto luminoso in alluminio pressofuso, verniciato a polvere opaca, fisso, lampadina retrocessa, fascio luminoso 30°, converter escluso

W2 = LED 2700K  
W3 = LED 3000K

LT: 25000h

A++ - A

IP 65

### NEW! CHICCO SQUARE LED

LED 7W · 350mA · CRI >90

308-0020790302705	W W2	30°	510lm
308-0020790302706	S W2	30°	455lm
308-0020790302704	S W2	30°	465lm
308-0020790303005	W W3	30°	555lm
308-0020790303006	S W3	30°	515lm
308-0020790303004	S W3	30°	525lm

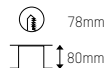
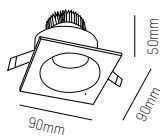

### CHICCO ROUND LED

LED 7W · 350mA · CRI >90

308-0010790302705	W W2	30°	510lm
308-0010790302706	S W2	30°	455lm
308-0010790302704	S W2	30°	465lm
308-0010790303005	W W3	30°	555lm
308-0010790303006	S W3	30°	515lm
308-0010790303004	S W3	30°	525lm

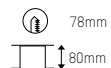
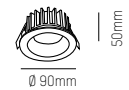

### LED CONVERTER CHICCO

Info: page 120-123

24-122598	W	350mA · schaltbar / switchable
24-123400	W	350mA · 1 - 10V / push dimm.
24-123403	W	350mA · DALI dimm.







Aufbauleuchte, Aluminium matt Feinstruktur pulverbeschichtet, quadratisch oder rund, AC-LED

Surface mounted luminaire, aluminium, matt powder-coated with fine textured paint, square or round, AC-LED

Lampada da soffitto in alluminio, verniciata a polvere opaca, quadrata o rotonda, AC-LED

W2 = LED 2700K  
W3 = LED 3000K

LT: 25000h



IP20

### BROOK SQUARE AC-LED

SYS 10W · 230V · CRI >90

472-0111090382756		465lm
472-0111090382706		455lm
472-0111090382763		495lm
472-0111090383056		515lm
472-0111090383006		505lm
472-0111090383063		550lm

### BROOK ROUND AC-LED

SYS 10W · 230V · CRI >90

472-0101090382756		465lm
472-0101090382706		450lm
472-0101090382763		490lm
472-0101090383056		515lm
472-0101090383006		500lm
472-0101090383063		545lm

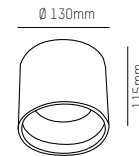
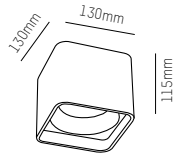





LED Aufbauleuchte aus Aluminium, matt Feinstruktur pulverbeschichtet, quadratisch oder rund, inkl. Konverter  
Version AEON BIG: Dali dimmbar



LED surface mounted luminaire made of aluminium, matt powder-coated with fine textured paint, square or round, incl. converter  
Version AEON BIG: DALI dimmable

Lampada da soffitto LED in alluminio, verniciata a polvere opaca, quadrata o rotonda, converter incluso  
Versione AEON BIG: dimmerabile DALI

**W2** = LED 2700K  
**W3** = LED 3000K





LT: 25000h

**A++** - **A**

IP20  

### AEON SMALL SQUARE LED





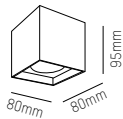







SYS 6,2W · 230V · CRI >80

305-602427w	  	430lm
305-602427b	  	430lm
305-602430w	  	495lm
305-602430b	  	495lm



### AEON SMALL ROUND LED





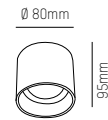

SYS 6,2W · 230V · CRI >80

305-602527w	  	475lm
305-602527b	  	475lm
305-602530w	  	510lm
305-602530b	  	510lm



### AEON BIG SQUARE LED





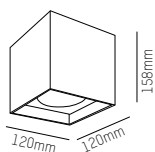



SYS 15,3W · 230V · CRI >80 DALI dimm.

305-604427wddd	  	1280lm
305-604427bddd	  	1280lm
305-604430wddd	  	1350lm
305-604430bddd	  	1350lm



### AEON BIG ROUND LED

SYS 15,3W · 230V · CRI >80 DALI dimm.

305-604527wddd	  	1280lm
305-604527bddd	  	1280lm
305-604530wddd	  	1350lm
305-604530bddd	  	1350lm

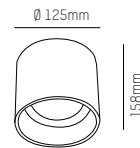

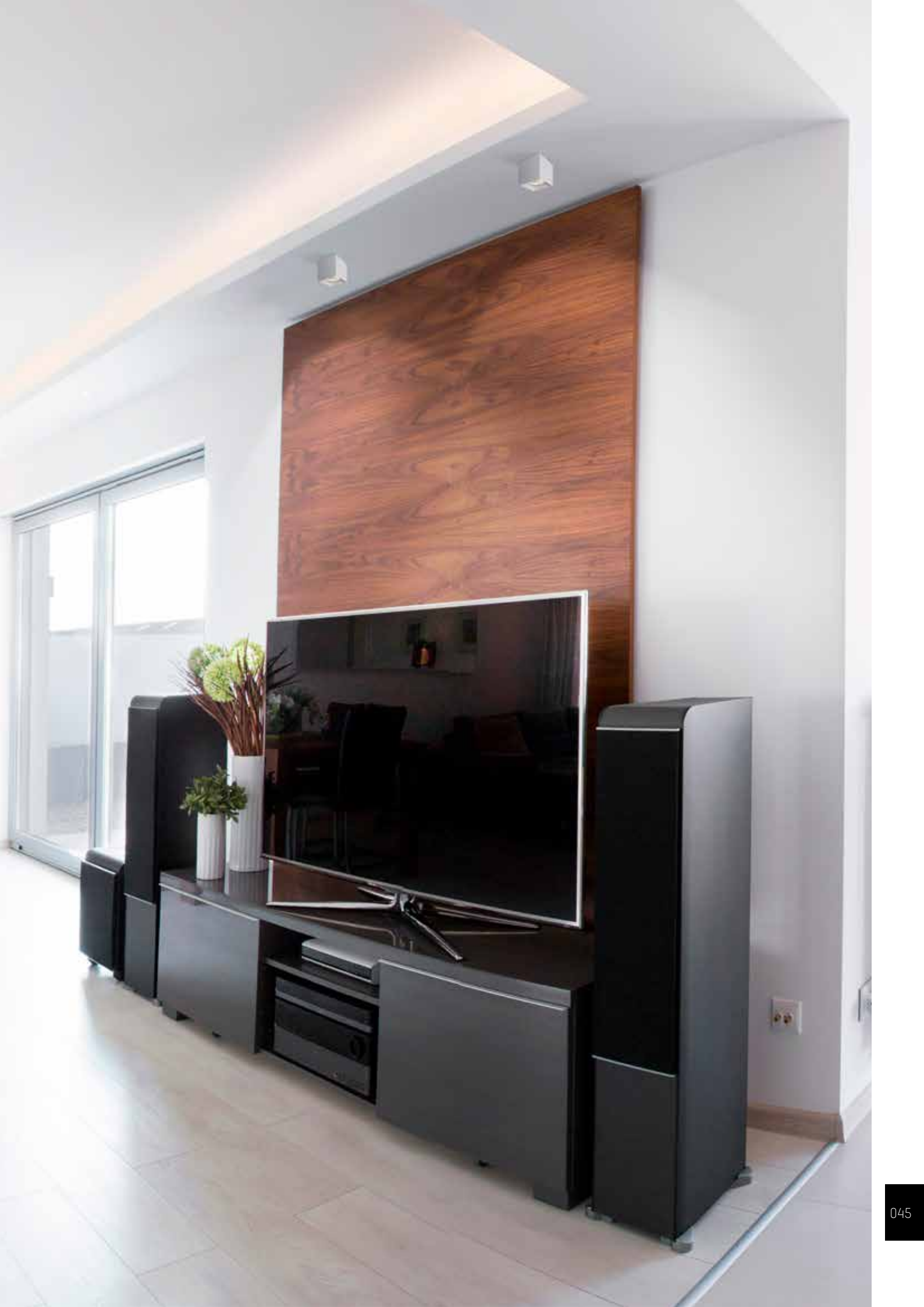



**POLUS**

Aufbauleuchte, Aluminiumdruckguss, weiß oder außen schwarz - innen weiß oder gold Feinstruktur pulverbeschichtet, inkl. Konverter 500mA

Surface mounted luminaire, die-cast aluminium, white or outside black/inside white or gold powder-coated, incl. converter 500mA

Lampada da soffitto in alluminio pressofuso, verniciata a polvere in bianco o oro oppure esterno nero e interno bianco, converter da 500 mA incluso

**UP AC**

Aufbauleuchte, AC-LED, Aluminium, weiß, schwarz oder grau Feinstruktur pulverbeschichtet, mit geschlossenem opalem Acryldiffusor, homogene Lichtverteilung



Surface mounted luminaire, AC-LED, aluminium, white, black or grey powder coated with fine textured paint, with closed opal acrylic diffuser, homogeneous light distribution

Lampada da soffitto, AC-LED, in alluminio, verniciata a polvere in bianco, nero o grigio, con diffusore acrilico opale a filo, illuminazione omogenea

**W2** = LED 2700K  
**W3** = LED 3000K

LT: 25000h

**A++** - **A**

IP20  

**POLUS LED**

SYS 11,3W · 230V · CRI >90

**276-0091190003005**

**W** **W3**

606lm

**276-0091190003063**

**S** **G** **W3**

580lm

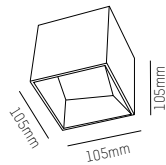

**UP AC-LED**

SYS 10W · 230V · CRI >90

**472-0501090002705**

**W** **W2**

576lm

**472-0501090002706**

**S** **W2**

461lm

**472-0501090002704**

**S** **W2**

486lm

**472-0501090003005**

**W** **W3**

640lm

**472-0501090003006**

**S** **W3**

515lm

**472-0501090003004**

**S** **W3**

540lm

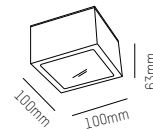





#### ARIK

Aufbauleuchte, Aluminiumdruckguss, matt Feinstruktur pulverbeschichtet, zylindrisch, Acryldiffusor matt satiniert, inkl. Konverter

Surface mounted luminaire, die-cast aluminium, matt powder-coated with fine textured paint, cylindrical, acrylic diffuser matt satined, incl. converter

Lampada da soffitto in alluminio pressofuso, verniciata a polvere opaca, cilindrica, diffusore acrilico satinato opaco, converter incluso

#### CARMİ A

Aufbauleuchte, Aluminiumdruckguss, Oberflächen matt Feinstruktur pulverbeschichtet, zylindrisch, AC-LED

Surface mounted luminaire, die-cast aluminium, matt powder-coated with fine textured paint, cylindrical, AC-LED

Lampada da soffitto in alluminio pressofuso, verniciata a polvere opaca, cilindrica, AC-LED

**W2** = LED 2700K  
**W3** = LED 3000K

LT: 25000h

**A++** - **A**

IP 20  

#### ARIK SHORT LED

SYS 11W · 230V · CRI >90

472-260029	<b>W</b> <b>W3</b>	360lm
472-260030	<b>S</b> <b>W3</b>	360lm

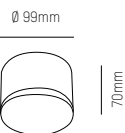

#### ARIK LONG LED

SYS 11W · 230V · CRI >90

472-260031	<b>W</b> <b>W3</b>	360lm
472-260032	<b>S</b> <b>W3</b>	360lm

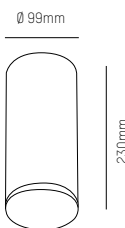

#### CARMİ AC-LED

SYS 10W · 230V · CRI >90

472-0121090002705	<b>W</b> <b>W</b> <b>W2</b>	552lm
472-0121090002706	<b>S</b> <b>S</b> <b>W2</b>	457lm
472-0121090002763	<b>S</b> <b>G</b> <b>W2</b>	487lm
472-0121090003005	<b>W</b> <b>W</b> <b>W3</b>	615lm
472-0121090003006	<b>S</b> <b>S</b> <b>W3</b>	510lm
472-0121090003063	<b>S</b> <b>G</b> <b>W3</b>	540lm

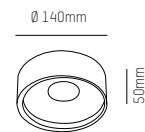







### TIA AC

Aufbaustrahler Aluminiumdruckguss, matt Feinstruktur pulverbeschichtet, Cover opal, starr, AC-LED, zurückversetzte Lichtquelle, hochwertiger vacuumbedampfter Aluminiumreflektor

Surface mounted spotlight, die-cast aluminium, matt powder-coated with fine textured paint, opal cover, fixed, AC-LED, recessed light source, high quality vacuum deposited aluminium reflector

Faretto da soffitto in alluminio pressofuso, verniciato a polvere opaca, diffusore opale, fisso, AC-LED, lampadina retrocessa, riflettore con deposizione di alluminio purissimo sottovuoto

### JOLENE

Aufbauleuchte, Aluminium schwarz Feinstruktur pulverbeschichtet, 30° Ausstrahlwinkel, Leuchtenkopf 60° dreh- / 30° schwenkbar, inkl. Konverter

Surface mounted luminaire, aluminium black powder-coated with fine textured paint, 30° beam angle, luminaire head 60° swiveling and 30° tilting, incl. converter

Lampada da soffitto in alluminio, verniciata a polvere, fascio luminoso 30°, testa 60° girevole e 30° orientabile, converter incluso

### NEW! TIA AC-LED

SYS 8W · 230V · CRI >90

472-0530890382705

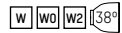

460lm

472-0530890382706

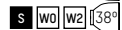

460lm

472-0530890383005

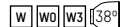

485lm

472-0530890383006

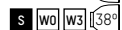

485lm

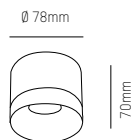

### JOLINE LED

SYS 20W · 230V · CRI >90

472-0291690383006



1340lm

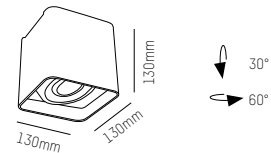

W2 = LED 2700K  
W3 = LED 3000K

LT: 25000h



IP 20







Aufbauleuchte 1- oder 2-flammig aus Aluminium, weiß, schwarz oder grau pulverbeschichtet, Leuchtenkopf: Vollaluminium gefräst, 30° dreh- / 30° schwenkbar

Surface mounted luminaire, 1 or 2 spotlights, aluminium, white, black or grey powder-coated, head: milled solid aluminium, 30° swivelling / 30° tilting

Lampada da plafone, 1 o 2 faretti, in alluminio, verniciatura a polveri in bianco, nero o grigio, testa in alluminio fresato, 30° girevole / 30° orientabile

**A++ - D**

IP 20  

### QANA BOX I HV

QPAR16 · GU10 · 230V · max. 35W or LED Retrofit

472-258951w

**W**

472-258951b

**S**

472-258951s

**S**

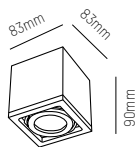

### QANA BOX II HV

2 x QPAR16 · GU10 · 230V · max. 2 x 35W or 2 x LED Retrofit

472-258952w

**W**

472-258952b

**S**

472-258952s

**S**

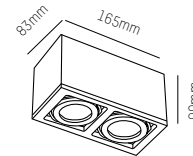





Aufbaustrahler, Aluminiumdruckguss, matt Feinstruktur pulverbeschichtet, Dekorring aus Metall (standardmäßig in Gehäusefarbe), Strahlerkopf 90° schwenk- und 350° drehbar, 40° Reflektor (im Lieferumfang enthalten), 20° oder 28° Reflektor separat bestellbar, Wand- oder Deckenmontage, inkl. Konverter 500mA - TRIAC dimmbar

Surface mounted spotlight, die-cast aluminium, matt powder-coated with fine textured paint, decoration ring made of metal (standard in housing colour), spotlight head 90° tilting and 350° swiveling, 40° reflector (included in scope of delivery), 20° or 28° reflector to order separately, wall or ceiling mounting, incl. converter 500mA - TRIAC dimmable

Faretto da soffitto o parete in alluminio pressofuso, verniciato a polvere opaca, anello decorativo in metallo (colore stabilito in base al colore della scatola), testa girevole 90° e 350° orientabile, riflettore 40° incluso, ordinare separatamente i riflettori da 20° o 28°, montaggio a parete oppure soffitto, converter 500mA incluso - dimmerabile TRIAC

W2 = LED 2700K  
W3 = LED 3000K

LT: 25000h

A++ - A

IP 20

### NEW! MAGIS LED

SYS 15,8W · 230V · CRI >90 TRIAC dimm.

276-0021590402705tr	W W2 40°	1030lm
276-0021590402706tr	S W2 40°	1030lm
276-0021590403005tr	W W3 40°	1070lm
276-0021590403006tr	S W3 40°	1070lm

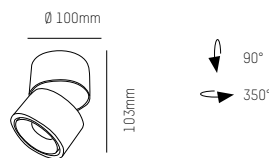

### NEW! MAGIS DOUBLE LED

SYS 30W · 230V · CRI >90 TRIAC dimm.

276-0103090402705tr	W W2 40°	2060lm
276-0103090402706tr	S W2 40°	2060lm
276-0103090403005tr	W W3 40°	2140lm
276-0103090403006tr	S W3 40°	2140lm

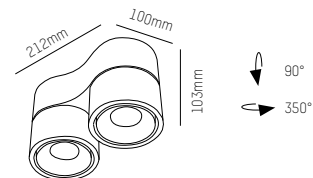

### NEW! DEKORRING/DECOR RING MAGIS & MAGIS DOUBLE

Metall pulverbeschichtet mit Magnethalterung / Metal powder-coated, monuting with magnet



### NEW! REFLEKTOR/REFLECTOR MAGIS & MAGIS DOUBLE

Werkzeuglos wechselbar, separat ordern / Mount without tools, order separatly







Aufbaustrahler, Aluminiumdruckguss, matt Feinstruktur pulverbeschichtet, Dekorring aus Metall (standardmäßig in Gehäusefarbe), Strahlerkopf 90° schwenk- und 350° drehbar, 50° Reflektor (im Lieferumfang enthalten), 23° oder 34° Reflektor separat bestellbar, Wand- oder Deckenmontage, inkl. Konverter 500mA - TRIAC dimmbar

Surface mounted spotlight, die-cast aluminium, matt powder-coated with fine textured paint, decoration ring made of metal (standard in housing colour), spotlight head 90° tilting and 350° swiveling, 50° reflector (included in scope of delivery), 23° or 34° reflector to order separately, wall or ceiling mounting, incl. converter 500mA - TRIAC dimmable

Faretto da soffitto o parete in alluminio pressofuso, verniciato a polvere opaca, anello decorativo in metallo (colore stabilito in base al colore della scatola), testa girevole 90° e 350° orientabile, riflettore 50° incluso, ordinare separatamente i riflettori da 23° o 34°, montaggio a parete oppure soffitto, converter 500mA incluso - dimmerabile TRIAC

W2 = LED 2700K  
W3 = LED 3000K

LT: 25000h

A++ - A

IP 20

### NEW! MAGIS MINI LED

SYS 11,1W · 230V · CRI >90 TRIAC dimm.

276-0111190502705tr	W W2 50°	615lm
276-0111190502706tr	S W2 50°	615lm
276-0111190503005tr	W W3 50°	630lm
276-0111190503006tr	S W3 50°	630lm

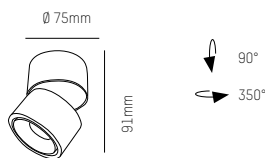

### NEW! MAGIS MINI DOUBLE LED

SYS 22,2W · 230V · CRI >90 TRIAC dimm.

276-0122190502705tr	W W2 50°	1230lm
276-0122190502706tr	S W2 50°	1230lm
276-0122190503005tr	W W3 50°	1260lm
276-0122190503006tr	S W3 50°	1260lm

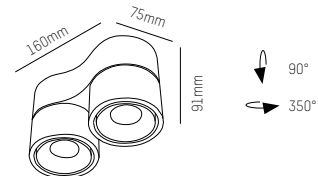

### NEW! DEKORRING/DECOR RING MAGIS I & MAGIS MINI DOUBLE

Metall pulverbeschichtet mit Magnethalterung / Metal powder-coated, monuting with magnet

276-7007 G



276-7008 W



276-7009 S



### NEW! REFLEKTOR/REFLECTOR MAGIS I & MAGIS MINI DOUBLE

Werkzeuglos wechselbar, separat ordern / Mount without tools, order separatly

276-7012 23°



276-7013 34°









Aufbaustrahler aus Aluminiumdruckguss, Feinstruktur matt pulverbeschichtet, AC-LED, zurückversetzte Strahlerköpfe 350° dreh- und 90° schwenkbar, hochwertige vacuumbedampfte Aluminiumreflektoren



Surface mounted spotlight made of die-cast aluminium, fine textured paint, matt powder-coated, AC-LED, recessed spotlight head 350° swiveling and 90° tilting, high quality vacuum deposited aluminium reflectors

Faretto da soffitto o parete in alluminio pressofuso, verniciato a polvere opaca, AC-LED, testa retrocessa 350° orientabile e 90° girevole, riflettore con deposizione di alluminio purissimo sottovuoto

**W2** = LED 2700K  
**W3** = LED 3000K





LT: 25000h

**A++** - **A**

IP20  

### NEW! NOEL AC-LED

SYS 2 x 8W · 230V · CRI >90

472-0541690112705	<b>W</b> <b>W2</b> 	750lm
472-0541690112706	<b>S</b> <b>W2</b> 	750lm
472-0541690113005	<b>W</b> <b>W3</b> 	770lm
472-0541690113006	<b>S</b> <b>W3</b> 	770lm

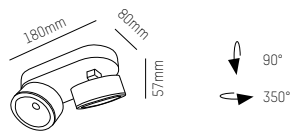





Dekorring innen standard schwarz  
Decor ring inside standard black



Aufbaustrahler, Aluminiumdruckguss, Feinstruktur matt pulverbeschichtet, Dekorring aus Kunststoff schwarz, Strahlerköpfe 90° schwenk- und 355° drehbar, 33° Ausstrahlwinkel, Wand- oder Deckenmontage, inkl. Konverter 500mA - TRIAC dimmbar

Surface mounted spotlight, die-cast aluminium, matt fine textured powder-coated, decoration ring in black synthetic, head 90° tilting and 355° swivelling, 33° beam angle, wall or ceiling mounting, incl. converter 500mA - TRIAC dimmable

Faretto da soffitto o parete in alluminio pressofuso, verniciato a polvere opaca, anello decorativo in plastica nera, testa 90° orientabile e 355° girevole, fascio luminoso 33°, montaggio a soffitto oppure a parete, converter 500mA - dimmerabile TRIAC incluso

**W3** = LED 3000K





LT: 25000h

**A++** - **A**

IP 20  

### MISSOR I LED

SYS 11,9W · 230V · CRI >90 TRIAC dimm.

- 276-0061290333056   33° 660lm
- 276-0061290333006   33° 660lm

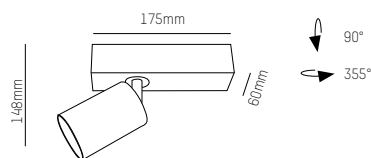

### MISSOR II LED

SYS 21,1W · 230V · CRI >90 TRIAC dimm.

- 276-0072190333056   33° 1340lm
- 276-0072190333006   33° 1340lm

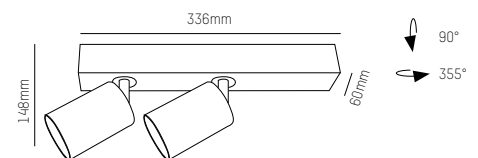

### DEKORRING/DECOR RING MISSOR

innenliegend, separat ordern / inside, order separately

- 276-7001 
- 276-7000 

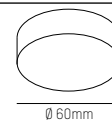

### WAABEN RASTER/HONEY COMB LOUVRE MISSOR

werkzeuglos montierbar / mount without tools

- 276-1002 







Aufbauleuchte, Aluminiumdruckguss, Feinstruktur matt pulverbeschichtet, 350° drehbar, verstellbarer Lichtkegel, inkl. Konverter



Surface mounted luminaire, die-cast aluminium, matt fine textured powder-coated, 350° swiveling, adjustable light cone, incl. converter

Lampada da soffitto in alluminio pressofuso, verniciata a polvere opaca, 350° girevole, fascio luminoso regolabile, converter incluso

**W3** = LED 3000K

LT: 25000h

**A++** - **A**

IP20  

### CEN LED

SYS 16W · 230V · CRI >90

472-260042

**W W3**

565lm

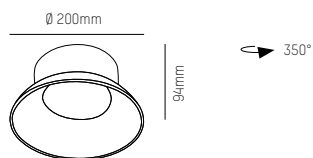



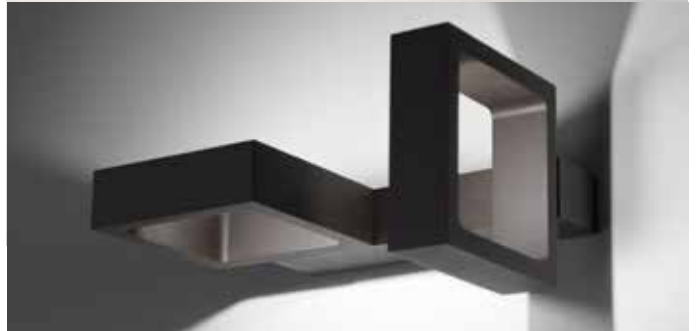

Wandleuchte, Aluminiumdruckguss, Feinstruktur matt pulverbeschichtet, direkt/indirekt strahlend, Leuchtenköpfe 345° drehbar, inkl. Konverter



Wall luminaire, die-cast aluminium, matt fine textured powder-coated, direct/indirect beam, head 345° swiveling, incl. converter

Lampada da parete in alluminio pressofuso, verniciata a polvere opaca, luce diretta/indiretta, testa 345° girevole, converter incluso

**W3** = LED 3000K

LT: 25000h

**A++** - **A**

IP20  

### BO SINGLE LED

SYS 5,2W · 230V · CRI >90

472-0080490003005

472-0080490003006

**W** **W3**

300lm

**S** **W3**

185lm

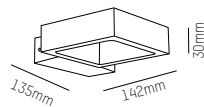

↻ 345°

### BO DOUBLE LED

SYS 2 x 5,2W · 230V · CRI >90

472-0090890003005

472-0090890003006

**W** **W3**

595lm

**S** **W3**

350lm

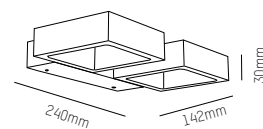

↻ 345°







#### CLARUS

Wandleuchte, Aluminiumdruckguss, matt Feinstruktur pulverbeschichtet, direkt/indirekt, asymmetrisch, 90°schwenkbar, 350° drehbar, inkl. Leselicht, inkl. Konverter

Wall luminaire, die-cast aluminium, matt fine textured powder-coated, direct/indirect beam, asymmetrical, 90° tilting, 350° swiveling, incl. reading light, incl. converter

Lampada da parete in alluminio pressofuso, verniciata a polvere opaca, luce diretta/indiretta, asimmetrica, 90° orientabile e 350° girevole, luce da lettura inclusa, converter incluso

#### BENTY LED

Wandleuchte, Aluminiumdruckguss, Feinstruktur matt pulverbeschichtet, geschlossener opaler Acryldiffusor, homogene Lichtverteilung, inkl. Konverter

Wall luminaire, die-cast aluminium, matt powder-coated with fine textured paint, closed opal acrylic diffuser, homogeneous light distribution, incl. converter

Lampada da parete in alluminio pressofuso, verniciata a polvere opaca, diffusore acrilico opale a filo, distribuzione della luce omogenea, converter incluso

**W2** = LED 2700K  
**W3** = LED 3000K

LT: 25000h



IP 20

#### NEW! CLARUS LED

SYS 10,8W · 230V · CRI >90

276-0151090402705tr

**W** **W2** 400lm

276-0151090402706tr

**S** **W2** 365lm

276-0151090402763tr

**S** **G** **W2** 365lm

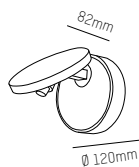

#### BENTY LED

SYS 5,7W · 230V · CRI >90

472-291007w

**W** **W3** 409lm

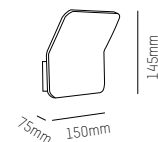

#### Funktionsweise der Leuchte CLARUS:

Erste Betätigung des Schalters: einschalten Grundlicht  
Zweite Betätigung des Schalters: einschalten Leselicht, ausschalten Grundlicht  
Dritte Betätigung des Schalters: aus  
Grundlicht & Leselicht können nicht gemeinsam leuchten.

#### Operating modes of luminaire CLARUS:

First mode of switch: switch on base-light  
Second mode of switch: switch on reading light  
Third mode of switch: off  
Base-light and reading light cannot be used in the same time

#### Modalità d'utilizzo della lampada CLARUS:

Prima modalità: luce basica  
Seconda modalità: luce da lettura, spegnimento luce basica  
Terza modalità: spento  
NB: luce basica e da lettura non possono essere utilizzate contemporaneamente



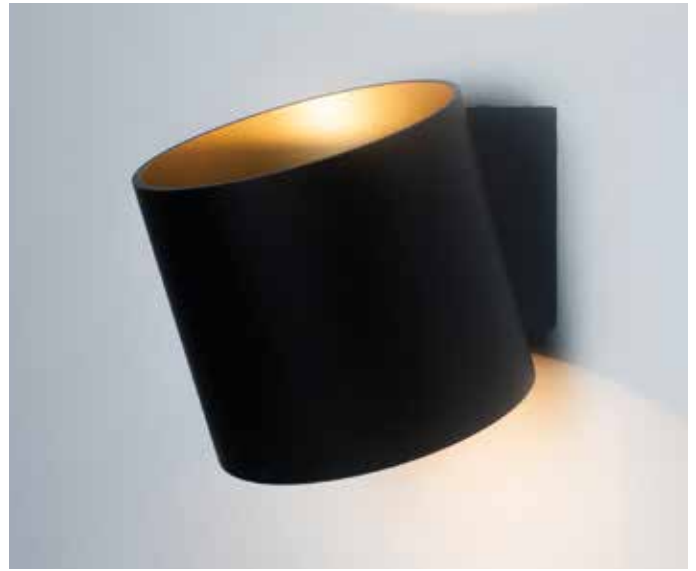

### TALOS

Wandleuchte, Aluminiumdruckguss, matt Feinstruktur pulverbeschichtet, direkt/indirekt strahlend, inkl. Konverter, TRIAC Dimmbar, INFO: asymmetrische Bauform

Wall luminaire, die-cast aluminium, matt powder-coated with fine textured paint, direct/indirect beam

Lampada da parete in alluminio pressofuso, verniciata a polvere opaca, luce diretta/indiretta, converter incluso, dimmerabile TRIAC, forma asimmetrica.

### OBLIQUUS

Wandleuchte, Aluminiumdruckguss, matt Feinstruktur pulverbeschichtet, direkt/indirekt, inkl. Konverter, TRIAC Dimmbar, INFO: asymmetrische Bauform

Wall luminaire die-cast aluminium, matt powder-coated with fine textured paint, direct/indirect beam, incl. converter, TRIAC dimmable, asymmetrical shape

Lampada da parete in alluminio pressofuso, verniciata a polvere opaca, luce diretta/indiretta, converter incluso, dimmerabile TRIAC, forma asimmetrica

**W2** = LED 2700K  
**W3** = LED 3000K

LT: 25000h

**A++** - **A**

IP 20  

### NEW! TALOS LED

SYS 14,2W · 230V · CRI >90 · TRIAC dimm.

276-0161490002705tr **W** **W2** 915lm  
276-0161490002763tr **S** **G** **W2** 820lm

276-0161490003005tr **W** **W3** 970lm  
276-0161490003063tr **S** **G** **W3** 870lm

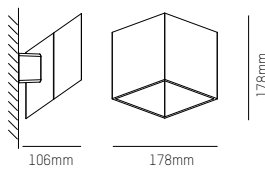

### NEW! OBLIQUUS LED

SYS 10,5W · 230V · CRI >90 · TRIAC dimm.

276-0141090002705tr **W** **W2** 595lm  
276-0141090002706tr **S** **W2** 550lm  
276-0141090002763tr **S** **G** **W2** 550lm

276-0141090003005tr **W** **W3** 685lm  
276-0141090003006tr **S** **W3** 605lm  
276-0141090003063tr **S** **G** **W3** 605lm

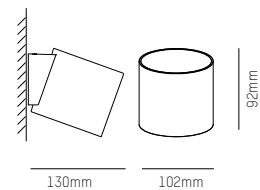





Wandleuchte, Aluminium, lackiert oder pulverbeschichtet, direkt/indirekt strahlend, inkl. Konverter TRIAC Dimmbar

Wall luminaire, aluminium, painted or powder-coated, direct/indirect beam, incl. converter TRIAC dimmable

Lampada da parete in alluminio laccato oppure verniciata a polvere, luce diretta/indiretta, converter dimmerabile TRIAC incluso

**W2** = LED 2700K

**W3** = LED 3000K

LT: 25000h











**A++** - **A**

IP 20  

## NOVEL LED

SYS 7,7W · 230V · CRI >90 · TRIAC dimm.

472-29100427wtr			359lm	
472-29100427btr			132lm	
472-29100427bgtr				189lm
472-29100427str			168lm	
472-29100427atr			263lm	

472-29100430wtr			399lm	
472-29100430btr			147lm	
472-29100430bgtr				210lm
472-29100430str			187lm	
472-29100430atr			292lm	

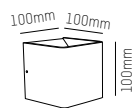





Wandleuchte, Aluminium, pulverbeschichtet oder lackiert, direkt/indirekt strahlend, inkl. Konverter

Wall luminaire, aluminium, painted or powder-coated, direct/indirect beam, incl. converter

Lampada da parete in alluminio laccato oppure verniciata a polvere, luce diretta/indiretta, converter incluso

W2 = LED 2700K  
W3 = LED 3000K

LT: 25000h



IP 20

### ALICA LED

SYS 7W · 230V · CRI >90

472-0000790002705			400lm	
472-0000790002706			215lm	
472-0000790002763				307lm
472-0000790002704			255lm	
472-0000790002714			320lm	
472-0000790003005			420lm	
472-0000790003006			220lm	
472-0000790003063				320lm
472-0000790003004			265lm	
472-0000790003014			330lm	

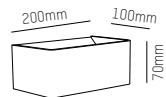







Wandleuchte, Aluminium, lackiert oder pulverbeschichtet, direkt/indirekt strahlend

Wall luminaire, aluminium, painted or powder-coated, direct/indirect beam, incl. converter

Lampada da parete in alluminio laccato oppure verniciata a polvere, luce diretta/indiretta

**A++** - **E**

IP 20  

## TAKE

QT14 ECO · G9 · 230V · max. 33W or LED Retrofit G9

472-291009w



472-291009b



472-291009s



472-291009a

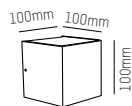





Wandleuchte, Aluminium, lackiert, flexiblem Arm, inkl. Konverter

Wall luminaire in aluminium, painted, flexible arm, incl. converter

Lampada da parete in alluminio laccato, braccio flessibile, converter incluso

**W3** = LED 3000K



LT: 25000h

**A++** - **A**

IP 20  

### ARCA LED

SYS 4,5W · 230V · CRI >80

365-300803325ng2   

190lm

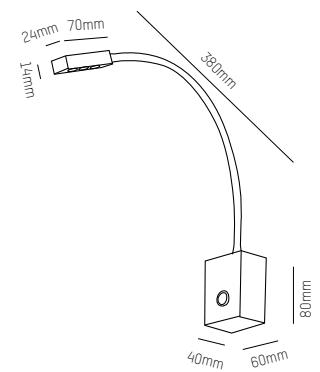

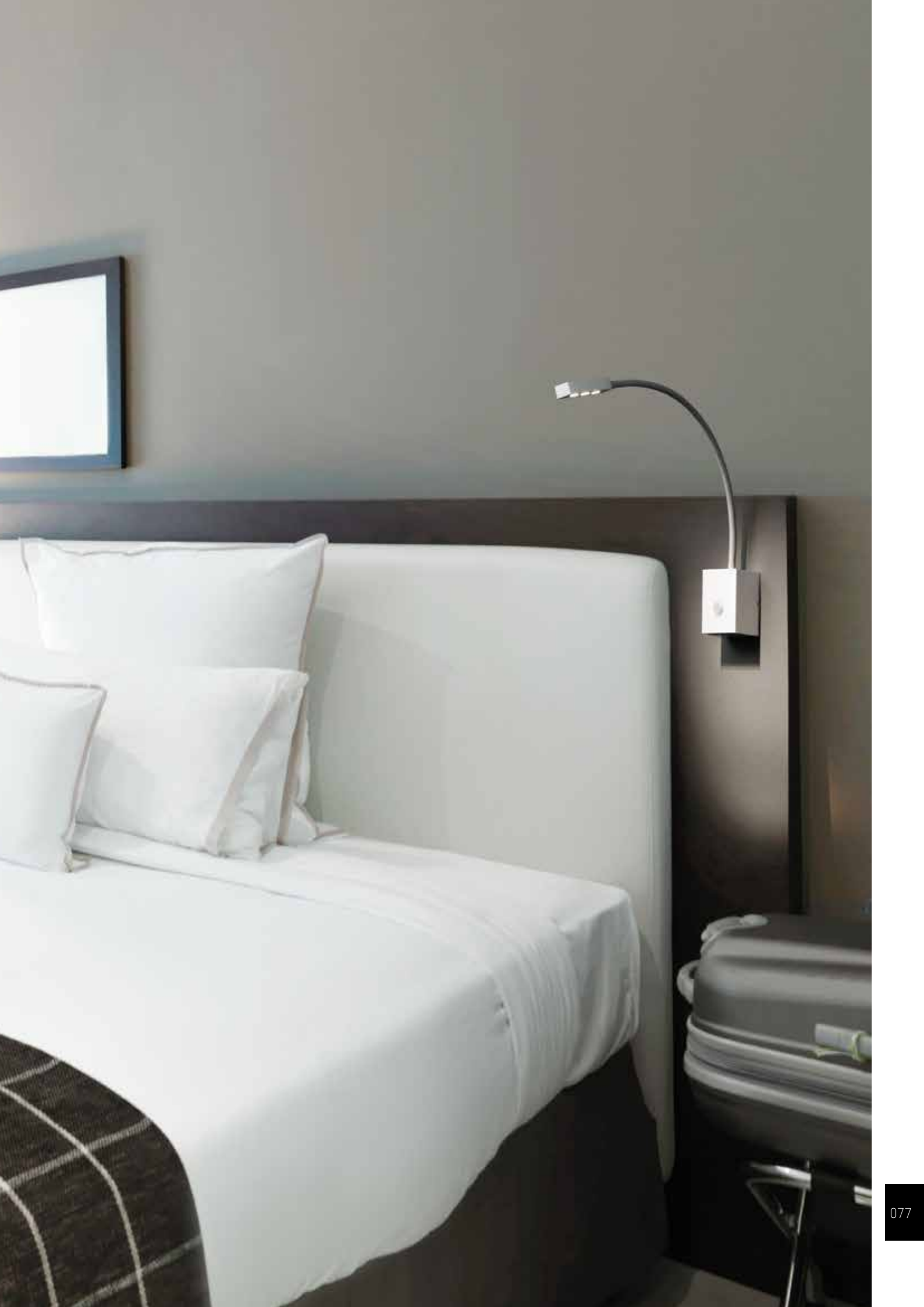



Touchdimmer wird mit gelbem LED-Punkt visualisiert  
Touch dimmer is visualized with a yellow LED-point



### NEONA

LED Wandleuchte mit flexiblem Arm aus Aluminium, matt Feinstruktur pulverbeschichtet, stufenlos TOUCH dimm., Touchdimmer ist mit gelbem LED-Punkt visualisiert. inkl. LED Konverter

LED wall luminaire with flexible arm made of aluminium, matt powder-coated with fine textured paint, continuous TOUCH dimmable, Touchdimmer is visualized with yellow LED spot, incl. converter

Lampada LED da parete con braccio flessibile in alluminio, verniciata a polvere opaca, TOUCH dimmerabile continuo, Touchdimmer è contrassegnato da un punto LED giallo, converter incluso

### NIA

LED Wandleuchte mit flexiblem Arm aus Aluminium, matt Feinstruktur pulverbeschichtet, inkl. LED Konverter



LED wall luminaire with flexible arm made of aluminium, matt powder-coated with textured paint, incl. converter

Lampada LED da parete con braccio flessibile in alluminio, verniciata a polvere opaca, converter LED incluso

**W3** = LED 3000K

LT: 25000h

**A++ - A**

IP 20  

### NEONA LED

SYS 3,7W · 230V · CRI >80 continuous TOUCH Dimm.

**365-1006w**



80lm

**365-1006b**



50lm

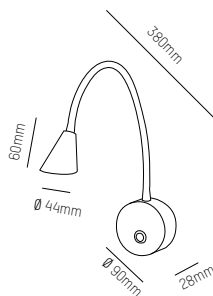

### NIA LED

SYS 4,5W · 230V · CRI >80

**365-1007w**



129lm

**365-1007b**



129lm

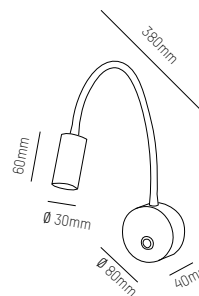

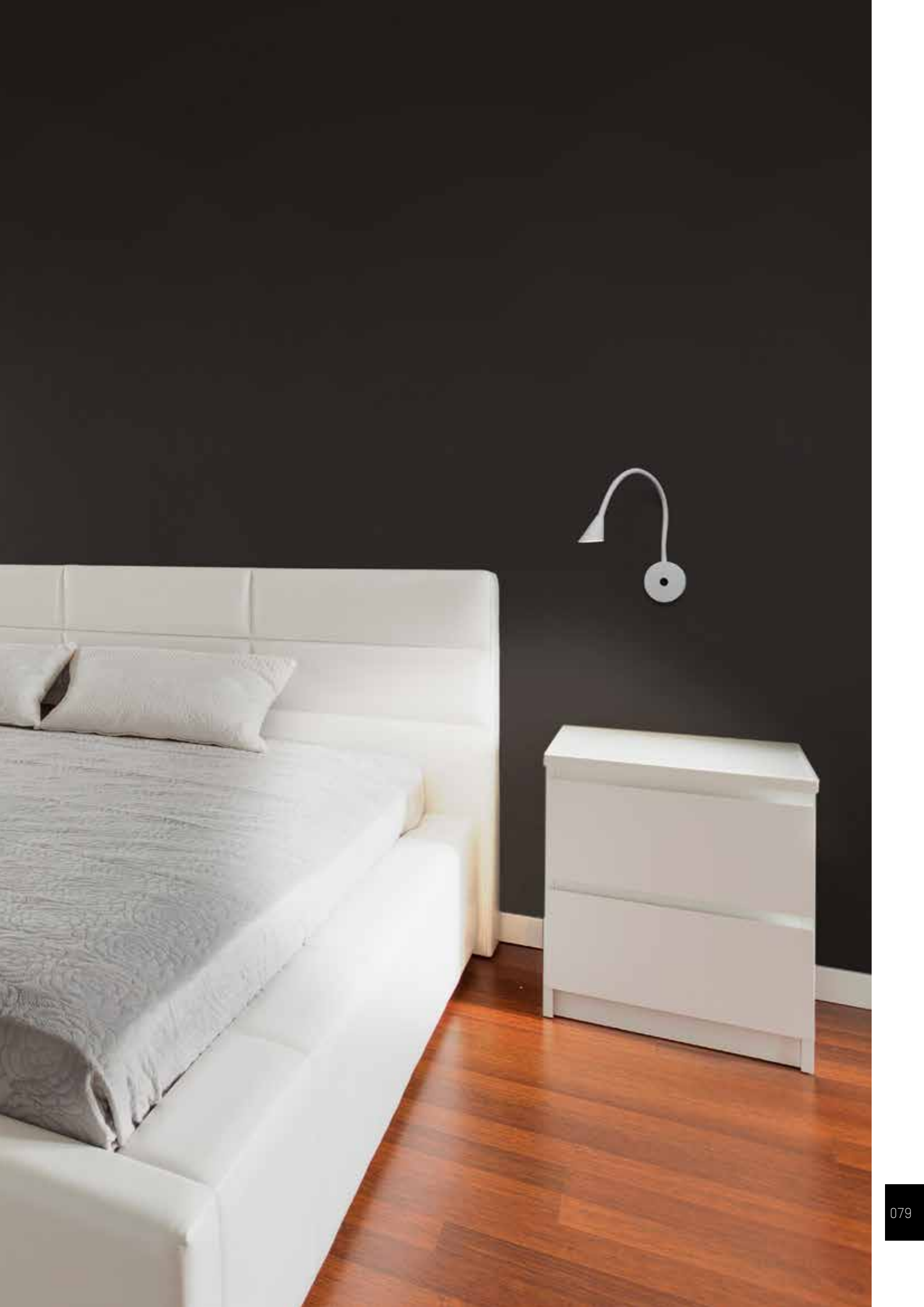



DENY E LED: Direkt/indirekt strahlend  
DENY E LED: direct/indirect light beam

Aufbauleuchte, Aluminiumdruckguss, matt Feinstruktur pulverbeschichtet, quadratisch, Diffusor aus opalem Acryl, Wand- oder Deckenmontage, inkl. Konverter 500mA - TRIAC dimmbar



Surface mounted luminaire, die-cast aluminium, matt powder-coated with fine textured paint, square, acrylic opal diffuser, wall or ceiling installation, incl. converter 500mA TRIAC dimmable

Lampada da soffitto in alluminio pressofuso, verniciata a polvere opaca, quadrata, diffusore opale in acrilico, montaggio a parete oppure a soffitto, converter 500mA - dimmerabile TRIAC

**W3** = LED 3000K

LT: 25000h

**A++ - A**

IP20  

#### DENY R LED

SYS 15,2W · 230V · CRI >90 · TRIAC dimm.

472-260048wtr

**W W3**

900lm

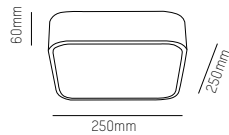

#### DENY E LED

SYS 15,2W · 230V · CRI >90 · TRIAC dimm.

472-260049wtr

**W W3**

900lm

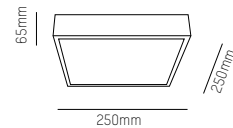







Hängeleuchte, Aluminiumdruckguss, matt pulverbeschichtet, 40° Ausstrahlwinkel, Kabellänge 1000mm, Baldachin DMxH=70x56mm, inkl. Konverter 320mA



Suspended luminaire, die-cast aluminium, matt powder-coated, 40° beam angle, cable length 1000mm, ceiling base DMxH 70x56mm, incl. converter 320mA

Lampada da sospensione in alluminio pressofuso, verniciata a polvere opaca, fascio luminoso 40°, lunghezza del cavo 1000mm, basetta DMxA 70x56mm, converter 320mA incluso

**W3** = LED 3000K

LT: 25000h

**A++** - **A**

IP20  

#### AMEA 200 LED

SYS 7,3W · 230V · CRI >90

365-1003w   346lm  
 365-1003b   346lm

#### AMEA 400 LED

SYS 7,3W · 230V · CRI >90

365-1004w   346lm  
 365-1004b   346lm

#### AMEA 600 LED

SYS 7,3W · 230V · CRI >90

365-1005w   346lm  
 365-1005b   346lm

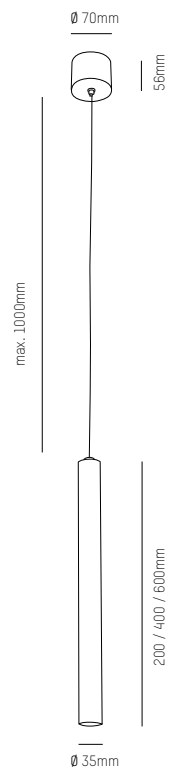





#### ATYS

Hängeleuchte, Aluminiumdruckguss, matt pulverbeschichtet, 32° Ausstrahlwinkel, Kabellänge 1000mm, Baldachin H=35mm, inkl. Konverter 350mA

Suspended luminaire, die-cast aluminium, matt powder-coated, 32° beam angle, cable length 1000mm, ceiling base height 35mm, incl. converter 350mA

Lampada da sospensione in alluminio pressofuso, verniciata a polvere opaca, fascio luminoso 32°, lunghezza del cavo 1000mm, altezza della basetta 35mm, converter 350mA incluso

#### GILO

Hängeleuchte, Aluminiumdruckguss, matt Feinstruktur pulverbeschichtet, Diffusor aus opalem Acryl, inkl. Konverter 500mA - TRIAC dimmbar



Suspended luminaire, die-cast aluminium, matt powder-coated with fine textured paint, acrylic opal diffuser, incl. converter TRIAC dimmable

Lampada da sospensione in alluminio pressofuso, verniciata a polvere opaca, diffusore opale in acrilico, converter 500mA - dimmerabile TRIAC incluso

**W3** = LED 3000K

LT: 25000h



IP 20  

#### ATYS LED

SYS 6,7W · 230V · CRI >90

<b>365-1002w</b>	  	324lm
<b>365-1002b</b>	  	324lm

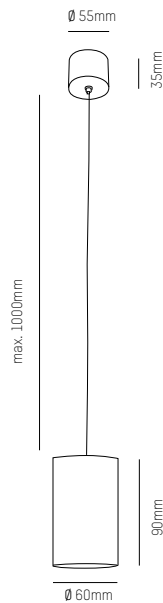

#### GILO LED

SYS 6,8W · 230V · CRI >90 · TRIAC dimm.

<b>472-260053wtr</b>	 	339lm
<b>472-260053btr</b>	 	339lm

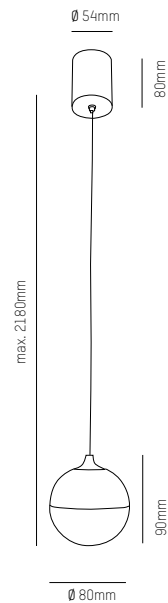









Hängeleuchte, Aluminiumdruckguss, matt Feinstruktur pulverbeschichtet, Diffusor aus opalem Acryl, inkl. Konverter 500mA - TRIAC dimmbar

Pendant luminaire, die-cast aluminium, matt fine textured powder coated, opal diffuser made of acryl, incl. converter 500mA - TRIAC dimmable

Lampada da parete in alluminio pressofuso, verniciata a polvere opaca, diffusore opale in acrilico, converter 500mA - dimmerabile TRIAC incluso

### NEW! MILO LED



SYS 6,6W · 230V · CRI >90

472-0550790002705		310lm
472-0550790002706		150lm
472-0550790003005		320lm
472-0550790003006		155lm

 = LED 3000K

LT: 25000h



IP20  

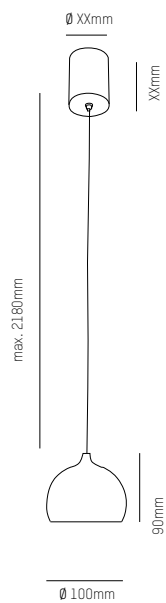



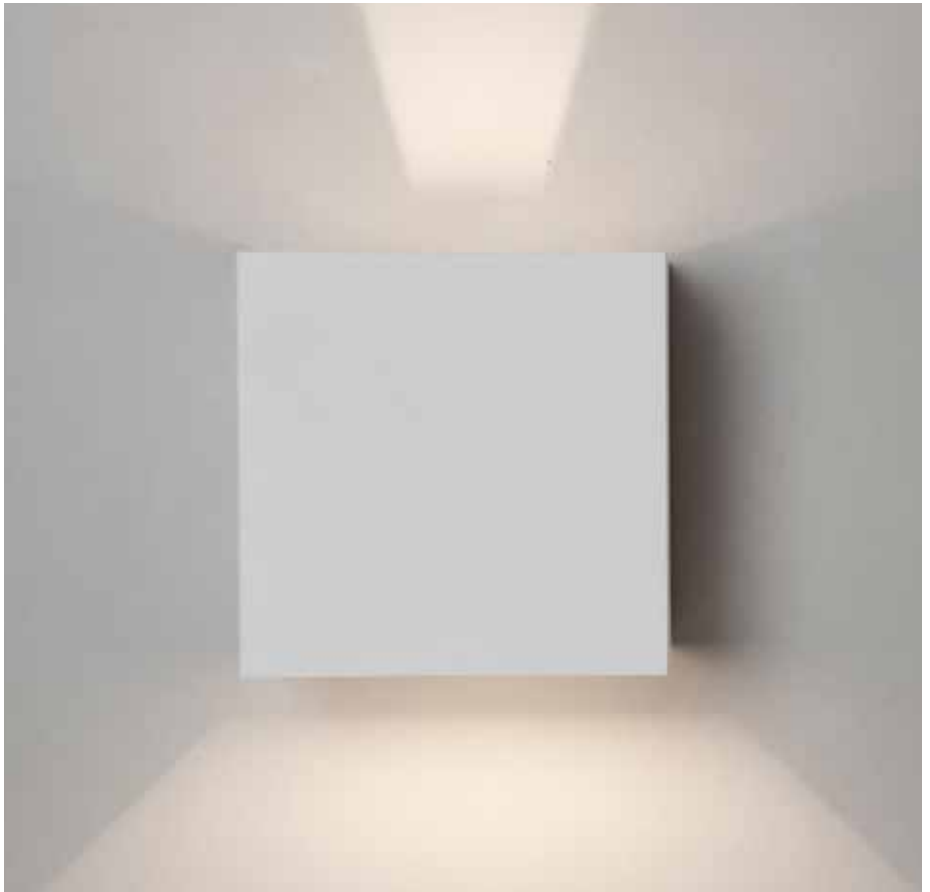

Wandleuchte, Aluminium, Feinstruktur matt pulverbeschichtet, schwenkbare Blenden für individuelle Lichtbildgestaltung, direkt/indirekt strahlend, inkl. Konverter

Wall luminaire, aluminium, matt powder-coated with fine textured paint, tiltable cover for individual light distribution, direct/indirect beam, incl. converter

Lampada da parete in alluminio, verniciata a polvere opaca, schermo orientabile per regolazione del flusso luminoso, luce diretta/indiretta, converter incluso

**W3** = LED 3000K

LT: 25000h

**A++** - **A**

**IP54**  

#### NEXT LED

SYS 7W · 230V · CRI >90

472-291008w	<b>W</b>	<b>W3</b>	210lm
472-291008s	<b>G</b>	<b>W3</b>	210lm
472-291008bgng1	<b>S</b>	<b>G</b> <b>W3</b>	210lm
472-291008ag	<b>AN</b>	<b>W3</b>	210lm

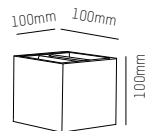







Wandleuchte, Aluminium, Feinstruktur matt pulverbeschichtet, schwenkbare Blenden für individuelle Lichtbildgestaltung, direkt/indirekt strahlend, inkl. Konverter

Wall luminaire in aluminium, matt powder-coated with fine textured paint, tiltable cover for individual light distribution, direct/indirect beam, incl. converter

Lampada da parete in alluminio, verniciata a polvere opaca, schermo orientabile per regolazione del flusso luminoso, luce diretta/indiretta, converter incluso

**W3** = LED 3000K

LT: 25000h

**A++** - **A**

**IP54**  

### KATHA I LED

SYS 7W · 230V · CRI >90

**472-645a11w**

**W** **W3**

210lm

**472-645a11s**

**G** **W3**

210lm

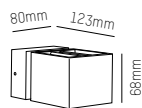





Wandleuchte, Aluminium, Feinstruktur matt pulverbeschichtet, direkt/indirekt strahlend, schwenkbare Blenden für individuelle Lichtbildgestaltung, inkl. Konverter

Wall luminaire in aluminium, matt powder-coated with fine textured paint, tiltable cover for individual light distribution, direct/indirect beam, incl. converter

Lampada da parete in alluminio, verniciata a polvere opaca, luce diretta/indiretta, schermo orientabile per regolazione del flusso luminoso, converter incluso

**W3** = LED 3000K

LT: 25000h

**A++** - **A**

**IP 54**  

### SKYE LED

SYS 16W · 230V · CRI >90

472-260025

**W** **W3**

550lm

472-260026

**G** **W3**

480lm

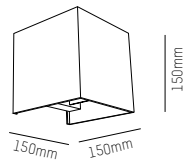



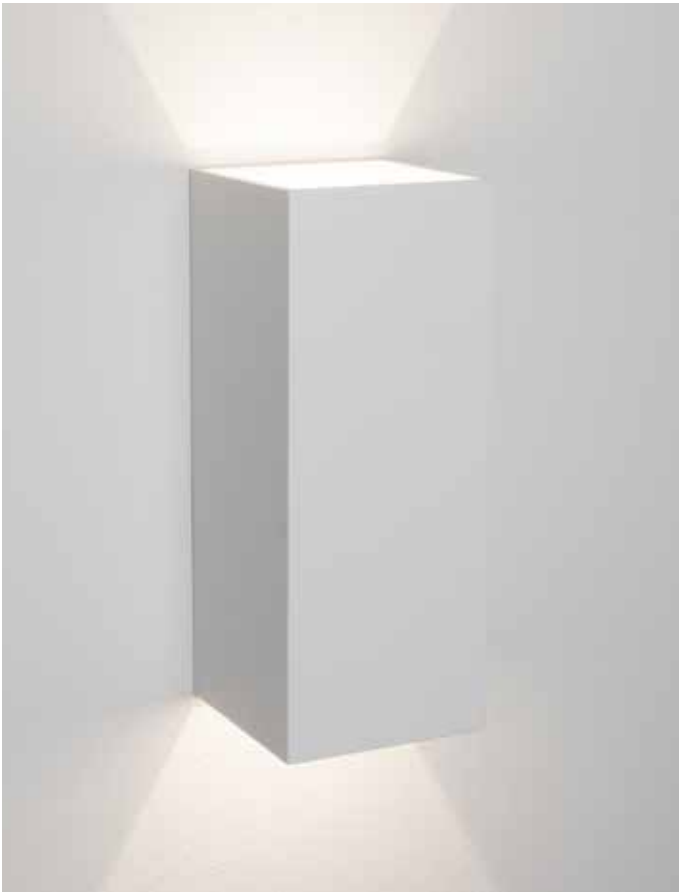

Wandleuchte, Aluminium, matt Feinstruktur pulverbeschichtet, rechteckig oder rund, direkt/indirekt strahlend, inkl. Konverter

Wall luminaire, aluminium, matt powder-coated with fine textured paint, rectangular or round, direct/indirect beam, incl. converter

Lampada da parete in alluminio, verniciata a polvere opaca, rettangolare oppure rotonda, luce diretta/indiretta, converter incluso

**W3** = LED 3000K

LT: 25000h

**A++ - A**

**IP 54**  

### BEN SQUARE LED

SYS 9W · 230V · CRI >90

472-0060890003005

**W** **W3**

525lm

472-0060890003004

**G** **W3**

360lm

472-0060890003011

**AN** **W3**

320lm

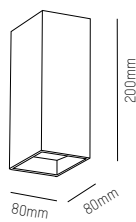

### BEN ROUND LED

SYS 9,2W · 230V · CRI >90

472-0050890003005

**W** **W3**

232lm

472-0050890003004

**G** **W3**

232lm

472-0050890003011

**AN** **W3**

232lm

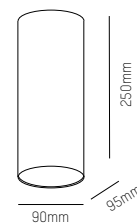





#### AVA

Wandleuchte, Aluminiumdruckguss, Feinstruktur matt pulverbeschichtet, direkt/indirekt strahlend, inkl. Konverter

Wall luminaire, die-cast aluminium, matt powder-coated with fine textured paint, direct/indirect beam, incl. converter

Lampada da parete in alluminio pressofuso, verniciata a polvere opaca, luce diretta/indiretta, converter incluso

#### PIATTA

Wandleuchte, Aluminiumdruckguss, Feinstruktur matt pulverbeschichtet, direkt strahlend, Diffuser PMMA opal, inkl. Konverter

Wall luminaire, die-cast aluminium, matt powder-coated with fine textured paint, direct/indirect beam, opal PMMA diffuser, incl. converter

Lampada da parete in alluminio pressofuso, verniciata a polvere opaca, luce diretta, diffusore opale microprismatico, converter incluso

**W3** = LED 3000K

LT: 25000h

**A++** - **A**

**IP 54**  

#### AVA LED

SYS 11W · 230V · CRI >90

**472-0030990003005**

**W** **W3** 780lm

**472-0030990003004**

**G** **W3** 480lm

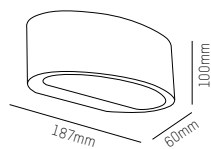

#### PIATTA LED

SYS 7W · 230V · CRI >90

**472-643m21w**

**W** **W3** 464lm

**472-643m21s**

**G** **W3** 308lm

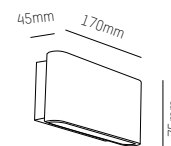







#### JAKE

Wandleuchte, Aluminiumdruckguss, Feinstruktur matt pulverbeschichtet, direkt/indirekt strahlend, inkl. Konverter

Wall luminaire, die-cast aluminium, matt powder-coated with fine textured paint, direct/indirect beam, incl. converter

Lampada da parete in alluminio pressofuso, verniciata a polvere opaca, luce diretta/indiretta, converter incluso

#### ZAHRA

Wandleuchte, Aluminiumdruckguss, Feinstruktur matt pulverbeschichtet, direkt/indirekt strahlend, inkl. Konverter

Wall luminaire, die-cast aluminium, matt powder-coated with fine textured paint, direct/indirect beam, incl. converter

Lampada da parete in alluminio pressofuso, verniciata a polvere opaca, luce diretta/indiretta, converter incluso

**W3** = LED 3000K

LT: 25000h

**A++** - **A**

**IP 54**  

#### JAKE LED

SYS 5,3W · 230V · CRI >90

**472-0280490003005**



230lm

**472-0280490003004**



230lm

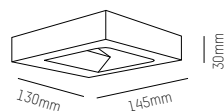

#### ZAHRA LED

SYS 7,6W · 230V · CRI >90

**472-260023**



320lm

**472-260024**



320lm

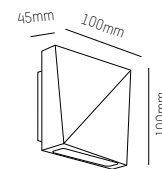





Wandleuchte, Aluminiumdruckguss, Feinstruktur matt pulverbeschichtet, kugelförmig, Linse aus Glas, 80° Ausstrahlwinkel, direkt/indirekt strahlend, inkl. Konverter 700mA - TRIAC dimmbar

Wall luminaire, die-cast aluminium, matt powder-coated with fine textured paint, spherical shape, glass lens, 80° beam angle, direct/indirect beam, incl. converter 700mA TRIAC dimmable

Lampada da parete in alluminio pressofuso, verniciata a polvere opaca, sferica, lente di vetro, fascio luminoso 80°, luce diretta/indiretta, converter 700mA - dimmerabile TRIAC incluso

**W3** = LED 3000K

LT: 25000h

**A++** - **A**

**IP 54**  

### NELL WALL LED

SYS 6,4W · 230V · CRI >90 TRIAC Dimm.

472-0370690003005



325lm

472-0370690003006



275lm

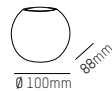





#### TUBE LED

Wandleuchte, Aluminium gefräst, gebürstet, direkt strahlend, inkl. Konverter

Wall luminaire, milled and brushed aluminium, direct beam, inkl. converter

Lampada da parete in alluminio fresato e spazzolato, luce diretta, converter incluso

#### TURN UP/DOWN LED

Wandleuchte, Aluminium gefräst, Feinstruktur matt pulverbeschichtet, direkt-/indirekt strahlend, inkl. Konverter

Wall luminaire, milled aluminium, matt powder-coated with fine textured paint, direct/indirect beam, inkl. converter

Lampada da parete in alluminio fresato, verniciata a polvere opaca, luce diretta/indiretta, converter incluso

**W3** = LED 3000K

LT: 25000h

**A++ - A**

**IP 54**  

#### TUBE LED

SYS 9W · 230V · CRI >90

472-256002



535lm

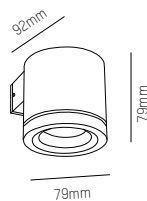

#### TURN UP/DOWN LED

SYS 14W · 230V · CRI >90

472-260043



840lm

472-260044



840lm

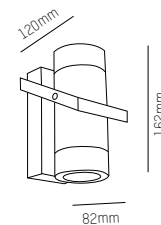





Wandleuchte, Aluminiumdruckguss, Feinstruktur matt pulverbeschichtet, opaler Diffusor und Klar-  
glasabdeckung, indirekt strahlend, inkl. Konverter

Wall luminaire, die-cast aluminium, matt powder-  
coated with fine textured paint, opal diffuser and  
clear glass cover, indirect beam, incl. converter

Lampada da parete in alluminio pressofuso, verni-  
ciata a polvere opaca, diffusore opale e copertura  
trasparente, luce indiretta, converter incluso

**W3** = LED 3000K

LT: 25000h

**A++** - **A**

**IP 54**  

### NEW! ZEON W LED

SYS 10W · 230V · CRI >90

472-0561090003006

**S** **W3**

320lm

472-0561090003011

**AM** **W3**

320lm

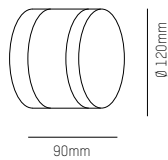







Wand- oder Deckenleuchte, Aluminiumdruckguss, Feinstruktur matt pulverbeschichtet, Diffusor aus opalem Acryl, AC-LED

Wall and ceiling luminaire, die-cast aluminium, matt powder-coated with fine textured paint, acrylic opal diffuser, AC-LED

Lampada da parete o soffitto in alluminio pressofuso, verniciata a polvere opaca, diffusore opale in acrilico, AC-LED

**W3** = LED 3000K

LT: 25000h

**A++** - **A**

**IP 54**  

### FYNN C AC-LED

SYS 10,7W · 230V · CRI >90

**472-260055s**

**G W3**

642lm

**472-260055ag**

**AN W3**

642lm

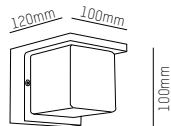

### FYNN O AC-LED

SYS 10,5W · 230V · CRI >90

**472-260056w**

**W W3**

790lm

**472-260056s**

**G W3**

790lm

**472-260056ag**

**AN W3**

790lm

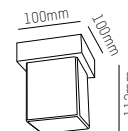





Aufbaustrahler, Aluminium gefräst, 90° schwenkbar

Surface mounted spotlight, milled aluminium, 90° tilting

Faretto da soffitto in alluminio fresato, 90° girevole

**A++** - **D**

**IP 54**  

### TURN II

QPAR16 · GU10 · 230V · max. 35W or LED Retrofit

472-256012

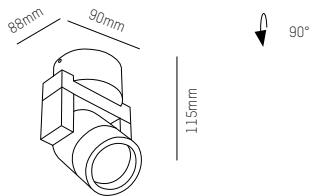





### LED FLUTER/FLOODLIGHT 30W

SYS 33,1W · 230V · CRI >70

263-3030s				2434lm
263-3040s				2490lm
263-3030b				2434lm
263-3040b				2490lm

mit Wandausleger / incl. wall bracket

263-3030sal				2434lm
263-3040sal				2490lm
263-3030bal				2434lm
263-3040bal				2490lm



### LED FLUTER/FLOODLIGHT 30W SENSOR

SYS 33,1W · 230V · CRI >70

mit Bewegungsmelder / incl. sensor

263-3030sp				2434lm
263-3040sp				2490lm
263-3030bp				2434lm
263-3040bp				2490lm

Fluter, Gehäuse aus Aluminiumdruckguss mit Kühlrippen, Feinstruktur matt pulverbeschichtet, 4mm starkes gehärtetes Glas, Silikondichtung, hochglanz Aluminiumreflektor, 270° schwenkbar, Metallbügel mit Winkelmessskala, inkl. Konverter

Floodlights, housing made of die-cast aluminium with cooling fins, matt powder-coated with fine textured paint, 5mm toughened glass, silicone seal, high-gloss aluminium reflector, 270° swiveling, metal bracket with angle measurement scale, incl. converter

Proiettore, telaio in alluminio pressofuso con dissipazione ad alette, verniciato a polvere opaca, vetro temperato di 4mm, guarnizione in silicone, riflettore in alluminio lucido, 270° girevole, supporto di metallo con scala graduata, converter incluso

= LED 3000K  
 = LED 4000K

LT: 25000h

IP65

### LED FLUTER/FLOODLIGHT 10W

SYS 10,2W · 230V · CRI >70

263-1030s				746lm
263-1040s				831lm
263-1030b				746lm
263-1040b				831lm

mit Wandausleger / incl. wall bracket L: 550 mm

263-1030sal				746lm
263-1040sal				831lm
263-1030bal				746lm
263-1040bal				831lm

### FLOODLIGHT 10W

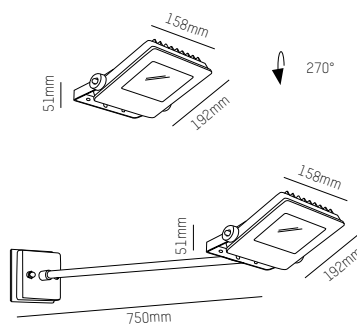

### LED FLUTER/FLOODLIGHT 50W

SYS 51,4W · 230V · CRI >70

263-5030s				4082lm
263-5040s				4158lm
263-5030b				4082lm
263-5040b				4158lm

mit Wandausleger / incl. wall bracket

263-5030sal				4082lm
263-5040sal				4158lm
263-5030bal				4082lm
263-5040bal				4158lm

### FLOODLIGHT 30 + 50W

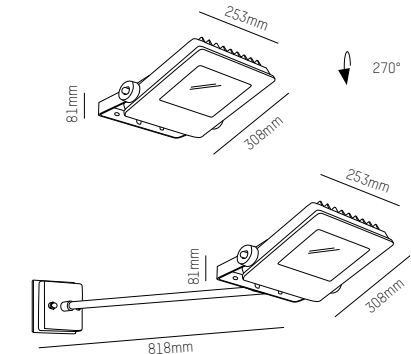





**JIB**

Auslegerleuchte, Aluminiumdruckguss, matt pulverbeschichtet, AC-LED, Leuchtenkopf 90° schwenkbar, 320° drehbar, **Montagehinweis: nur direkt strahlend!**

Luminaire with arm, die-cast aluminium, matt powder-coated, AC-LED, head 90° tilting and 320° swiveling, **mounting indication: only direct beam!**

Lampada a braccio, in alluminio pressofuso, verniciata a polvere opaca, AC-LED, testa 90° girevole e 320° orientabile, **indicazione per il montaggio: solo luce diretta!**

**VIDERI**

Auslegerleuchte, Aluminiumdruckguss, matt pulverbeschichtet, AC-LED, Leuchtenkopf 120° schwenkbar, 140° drehbar, **Montagehinweis: nur direkt strahlend!**

Luminaire with arm, die-cast aluminium, matt powder-coated, AC-LED, head 120° tilting and 140° swiveling, **mounting indication: only direct beam!**

Lampada a braccio, in alluminio pressofuso, verniciata a polvere opaca, AC-LED, testa 120° girevole e 140° orientabile, **indicazione per il montaggio: solo luce diretta!**

**W3** = LED 3000K

LT: 25000h



**NEW! JIB**

SYS 8W · 230V · CRI >80

- 341-0000880503004 475lm
- 341-0000880503011 475lm

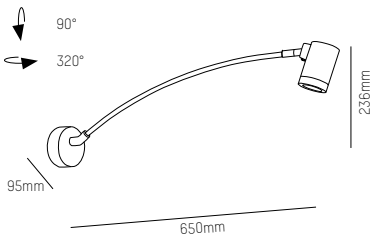

**NEW! VIDERI SHORT**

SYS 15W · 230V · CRI >80

- 341-0031580003004 910lm
- 341-0031580003011 910lm

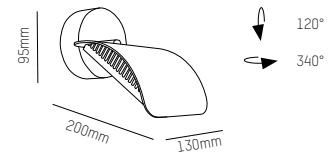

**NEW! VIDERI LONG**

SYS 15W · 230V · CRI >80

- 341-0021580003004 910lm
- 341-0021580003011 910lm

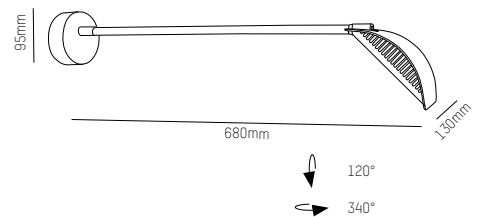





**JAZZ**  
FESTIVAL  
LIVE MUSIC ONLY - BEST ARTISTS

THEATER  
**1.03-25.04**

WALTER SCOT      FILL MERISMO  
JIMMY BERMINGER      JANET BERDOVSKY

**TICKETS ON SALE NOW**

[WWW.JAZZFESTIVALLOREHIPSUM.COM](http://WWW.JAZZFESTIVALLOREHIPSUM.COM)



**JAZZ**  
FESTIVAL  
LIVE MUSIC ONLY - BEST ARTISTS

THEATER  
**1.03-25.04**

WALTER SCOT      FILL MERISMO  
JIMMY BERMINGER      JANET BERDOVSKY

**TICKETS ON SALE NOW**

[WWW.JAZZFESTIVALLOREHIPSUM.COM](http://WWW.JAZZFESTIVALLOREHIPSUM.COM)



**HARK**

Aufbaustrahler, AC-LED, Aluminiumdruckguss, Feinstruktur matt pulverbeschichtet, Diffusor aus Glas, 40° Ausstrahlwinkel, 350° dreh- und 90° schwenkbar, inkl. 168mm Erdspieß

Surface mounted spotlight, AC-LED, die-cast aluminium, matt powder-coated with fine textured paint, glass diffuser, 40° beam angle, 350° swiveling and 90° tilting, incl. 168mm ground spike

Faretto da soffitto, AC-LED, alluminio pressofuso, verniciato a polvere opaca, diffusore in vetro, fascio luminoso 40°, 350° girevole e 90° orientabile, picchetto da 168mm incluso

**FORIS**

Strahler, Aluminiumdruckguss, matt pulverbeschichtet, AC-LED, Leuchtekopf 330° drehbar und 90° schwenkbar, inkl. Erdspieß, Entblendungsring in zwei Ausführungen als Zubehör separat ordern

Spotlight, die-cast aluminium, matt powder-coated, AC-LED, luminaire head 330° swiveling and 90° tilting, incl. ground spike, anti-glare ring in two performances to be ordered separately as accessory

Faretto in alluminio pressofuso, verniciato a polvere opaca, AC-LED, testa 330° girevole e 90° orientabile, picchetto incluso, anello antiabbagliamento come accessorio disponibile in due versioni da ordinare separatamente

**W3** = LED 3000K

LT: 25000h

**A++ - A**

**IP 65**  

**HARK AC-LED**

SYS 4,7W · 230V · CRI >80

472-0250480403011  255lm

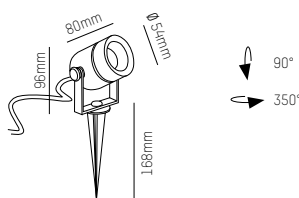

**NEW! FORIS AC-LED**

SYS 10W · 230V · CRI >80

341-0011080503011  740lm

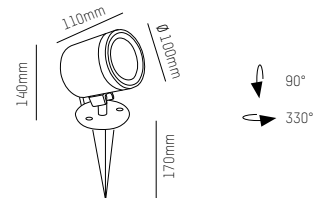

**NEW! ENTBLENDUNGSRING / NO GLARE RING**

mit Schraubverschluss / with screw lock

341-7000 Leuchte / Luminaire = 525lm

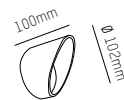

**NEW! ENTBLENDUNGSKREUZRASTER**

**NEW! NO GLARE LOUVRE**

mit Schraubverschluss / with screw lock

341-7001 Leuchte / Luminaire = 550lm

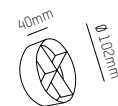





**MENDO**

Pollerleuchte, Feinstruktur matt pulverbeschichtet, inkl. Konverter

Bollard luminaire, die-cast aluminium, matt powder-coated with fine textured paint, incl. converter

Bollard in alluminio pressofuso, verniciata a polvere opaca, converter incluso

**FYNN CP AC**

Pollerleuchte, AC-LED, Aluminium Feinstruktur pulverbeschichtet, Diffusor aus opalem Acryl

Bollard luminaire, AC-LED, die-cast aluminium, matt powder-coated with fine textured paint, acrylic opal diffuser

Bollard, AC-LED, verniciato a polvere opaca, diffusore opale in acrilico

**W3** = LED 3000K

LT: 25000h

**A++ - A**

**IP 54**  

**MENDO LED**

SYS 8W · 230V · CRI >90

- 472-260046  313lm
- 472-260047  313lm

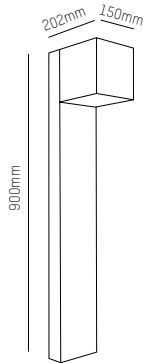

**FYNN CP AC-LED**

SYS 10W · 230V · CRI >90

- 472-260057s  642lm
- 472-260057ag  642lm

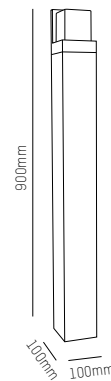





#### YARA FLAT

Pollerleuchte, Aluminiumdruckguss, Feinstruktur matt pulverbeschichtet, PC-Diffusor klar, 180° Ausstrahlwinkel, inkl. Konverter 120mA

Bollard luminaire, die-cast aluminium, matt powder-coated with fine textured paint, clear polycarbonate diffuser, 180° beam angle, incl. converter 120mA

Bollard in alluminio pressofuso, verniciato a polvere opaca, diffusore in policarbonato trasparente, fascio luminoso 180°, converter 120mA incluso

#### ZEON P

Pollerleuchte, Aluminiumdruckguss, Feinstruktur matt pulverbeschichtet, opaler Diffusor und Klar-glasabdeckung, indirekt strahlend, inkl. Konverter

Bollard luminaire, die-cast aluminium, matt powder-coated with fine textured paint, opal diffuser and transparent cover, indirect beam, incl. converter

Bollard in alluminio pressofuso, verniciato a polvere opaca, diffusore opale e copertura trasparente, luce indiretta, converter incluso

**W3** = LED 3000K

LT: 25000h

**A++** → **A**

**IP 54** ⚡ ⚠

#### YARA FLAT LED

SYS 10,4W · 230V · CRI >80

273-1000s

**G W3** 1360° 800lm

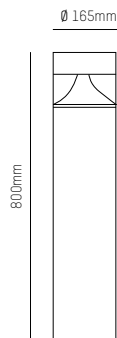

#### NEW! ZEON P LED

SYS 12,2W · 230V · CRI >90

472-0571390003006

472-0571390003011

**S W3** 1360° 390lm  
**AN W3** 1360° 390lm

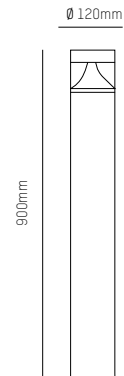





Pollerleuchte, Aluminium, Feinstruktur matt pulverbeschichtet, inkl. Konverter

Bollard luminaire, aluminium, matt powder-coated with fine textured paint, incl. converter

Bollard in alluminio, verniciato a polvere opaca, converter incluso

**W3** = LED 3000K

LT: 25000h

**A++** - **A**

**IP 54**  

### CITI SHORT LED

SYS 7W · 230V · CRI >90

472-685813c30s



263lm

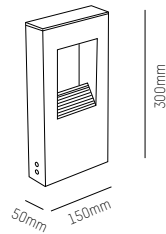

### CITI LONG LED

SYS 7W · 230V · CRI >90

472-686013c60s



263lm

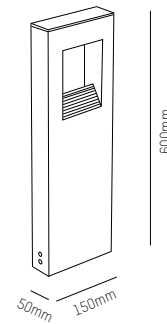







Pollerleuchte Aluminium gefräst, klar lackiert,  
Diffusor aus opalem Glas, Grundplatte oder Erdspieß  
separat ordern

Bollard luminaire, milled aluminium, clear painted,  
opal glass diffuser, ground plate and ground spike  
to be ordered separately

Bollard in alluminio fresato, laccatura trasparente,  
diffusore in vetro opale, basetta e picchetto da  
ordinare separatamente

**A++** - **D**

**IP 54**  

### GAIA

QT14-ECO · G9 · 230V or LED Retrofit

472-256075



### ERDSPIESS / GROUND STAKE

472-256079



### GRUNDPLATTE / MOUNTING PLATE

472-256078

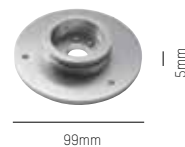



## LED CONVERTER BULL/U

INFO	W	mA	V DC	LxB/WxH	FARBE / COLOUR	ART. NR. / CODE
 <p>LED-Konverter, <b>nicht dimmbar</b>, 230 V AC LED-Converter, <b>not dimmable</b>, 230 V AC</p>	8	350	24	60x35x21,5	<b>W</b>	24-122598



## LED CONVERTER STM/U / MPL

INFO	W	mA	V DC	LxB/WxH	FARBE / COLOUR	ART. NR. / CODE
 <p>LED-Konverter, <b>nicht dimmbar</b>, 230 V AC LED-Converter, <b>not dimmable</b>, 230 V AC</p>	6	250	24	42x40 x22	<b>S</b>	24-122812



## LED CONVERTER MP15

INFO	W	mA	V DC	LxB/WxH	FARBE / COLOUR	ART. NR. / CODE
 <p>LED-Konverter, <b>nicht dimmbar</b>, 230 V AC LED-Converter, <b>not dimmable</b>, 230 V AC</p>	2,5 - 15	60 - 360	41,5	115x34x19	<b>W</b>	24-122360



Einstellbar mittels DIP-SWITCH:

Adjustable with DIP-SWITCH:

mA	W	V DC	mA	W	V DC
60	2,5	41,5	220	9,1	41,5
80	3,3	41,5	240	10	41,5
100	4,1	41,5	260	10,8	41,5
120	5	41,5	280	11,6	41,5
140	5,8	41,5	300	12,4	41,5
160	6,6	41,5	320	13,2	41,5
180	7,4	41,5	340	14,1	41,5
200	8,3	41,5	360	15	41,5

## LED CONVERTER UNIVERSALE 20 LC

INFO	W	mA	V DC	LxB/WxH	FARBE / COLOUR	ART. NR. / CODE
 <p>LED-Konverter, <b>nicht dimmbar</b>, 230 V AC LED-Converter, <b>not dimmable</b>, 230 V AC</p>	5,4 - 20	100 - 380	54	111x52x22	<b>W</b>	24-122203



Einstellbar mittels DIP-SWITCH:

Adjustable with DIP-SWITCH:

Konstantstrom / constant current

mA	W	V DC	mA	W	V DC
100	5,5	54	260	14,3	54
140	7,7	54	300	16,5	54
180	9,9	54	340	18,6	52
220	12	54	380	20	52

Konstantspannung / constant voltage

W	V DC
9	24

## LED CONVERTER UNIVERSALE 20

INFO	W	mA	V DC	LxB/WxH	FARBE / COLOUR	ART. NR. / CODE
 <p>LED-Konverter, <b>nicht dimmbar</b>, 230 V AC LED-Converter, <b>not dimmable</b>, 230 V AC</p>	13 - 20	250 - 700	57 - 28	111x52x22	<b>W</b>	24-122201



Einstellbar mittels DIP-SWITCH:

Adjustable with DIP-SWITCH:

Konstantstrom / constant current

mA	W	V DC	mA	W	V DC
250	13	57	500	20	40
350	19	57	550	20	36
400	20	50	600	20	33
450	20	44	700	20	28

Konstantspannung / constant voltage

W	V DC
16	24

## LED CONVERTER MP 50 K3

INFO	W	mA	V DC	LxB/WxH	FARBE / COLOUR	ART. NR. / CODE
 <p>LED-Konverter, <b>nicht dimmbar</b>, 230 V AC LED-Converter, <b>not dimmable</b>, 230 V AC</p>	25 - 50	350 - 1050	74 - 48	124x79x22	<b>W</b>	24-122204



Einstellbar mittels DIP-SWITCH:

Adjustable with DIP-SWITCH:

mA	W	V DC	mA	W	V DC
350	25	74	750	50	66
500	35	72	850	50	58
550	39	72	900	50	55
650	46	72	1050	50	48
700	50	71			

## LED CONVERTER MINI JOLLY HV

INFO	W	mA	V DC	LxB/WxH	FARBE / COLOUR	ART. NR. / CODE
 <p>LED-Konverter, <b>nicht dimmbar</b>, 230 V AC LED-Converter, <b>not dimmable</b>, 230 V AC</p>	13 - 20	250 - 700	53 - 29	111x52x22	<b>W</b>	24-123399



Einstellbar mittels DIP-SWITCH:

Adjustable with DIP-SWITCH:

Konstantstrom / constant current

mA	W	V DC	mA	W	V DC
250	13	53	500	20	40
350	17	52	550	20	37
400	20	50	600	20	34
450	20	44	700	20	29

Konstantspannung / constant voltage

W	V DC
18	24
20	48

### LED CONVERTER MINI JOLLY 20 LC



INFO	W	mA	V DC	LxB/WxH	FARBE / COLOUR	ART. NR. / CODE
LED-Konverter, 1-10V, PUSH dimm, 230 V AC LED-Konverter, 1-10V, PUSH dimm, 230 V AC	6,4 - 20	100 - 380	54	111x52x22	<b>W</b>	24-123401

Einstellbar mittels DIP-SWITCH:  
Adjustable with DIP-SWITCH:

Konstantstrom / constant current					
mA	W	V DC	mA	W	V DC
100	5,5	54	260	14,3	54
140	7,7	54	300	16,5	54
180	9,9	54	340	18,6	55
220	12	54	380	20	55

Konstantspannung / constant voltage	
W	V DC
9	24

### LED CONVERTER MINI JOLLY 20



INFO	W	mA	V DC	LxB/WxH	FARBE / COLOUR	ART. NR. / CODE
LED-Konverter, 1-10V, PUSH dimm, 230 V AC LED-Konverter, 1-10V, PUSH dimm, 230 V AC	15 - 20	350 - 900	43 - 22	111x52x22	<b>W</b>	24-123400

Einstellbar mittels DIP-SWITCH:  
Adjustable with DIP-SWITCH:

Konstantstrom / constant current					
mA	W	V DC	mA	W	V DC
350	15	43	700	20	36
500	20	43	850	20	24
550	20	43	900	20	22

Konstantspannung / constant voltage			
W	V DC	W	V DC
9	10	20	24
10	12		

### LED CONVERTER MINI JOLLY 20 LC



INFO	W	mA	V DC	LxB/WxH	FARBE / COLOUR	ART. NR. / CODE
LED-Konverter, DALI dimm, 230 V AC LED-Konverter, DALI dimm, 230 V AC	5,4 - 20	100 - 380	54 - 51	111x52x22	<b>W</b>	24-123395

Einstellbar mittels DIP-SWITCH:  
Adjustable with DIP-SWITCH:

Konstantstrom / constant current					
mA	W	V DC	mA	W	V DC
100	5,4	54	260	14	54
140	7,5	54	300	16	54
180	10	54	340	18	52
220	12	54	380	20	52

Konstantspannung / constant voltage	
W	V DC
9	24

### LED CONVERTER MINI JOLLY 20



INFO	W	mA	V DC	LxB/WxH	FARBE / COLOUR	ART. NR. / CODE
LED-Konverter, DALI dimm, 230 V AC LED-Konverter, DALI dimm, 230 V AC	10 - 20	250 - 700	43 - 28	111x52x22	<b>W</b>	24-123403

Einstellbar mittels DIP-SWITCH:  
Adjustable with DIP-SWITCH:

Konstantstrom / constant current					
mA	W	V DC	mA	W	V DC
250	10	43	500	20	40
350	15	43	550	20	36
400	17	43	600	20	33
450	19	43	700	20	28

Konstantspannung / constant voltage	
W	V DC
16	24

### LED CONVERTER MAXI JOLLY US 50



INFO	W	mA	V DC	LxB/WxH	FARBE / COLOUR	ART. NR. / CODE
LED-Konverter, 1-10V, PUSH & DALI dimm, 230 V AC LED-Konverter, 1-10V, PUSH & DALI dimm, 230 V AC	25 - 50	350 - 1050	74 - 48	124x79x22	<b>W</b>	24-123413

Einstellbar mittels DIP-SWITCH:  
Adjustable with DIP-SWITCH:

Konstantstrom / constant current					
mA	W	V DC	mA	W	V DC
350	25	74	750	50	66
500	35	72	850	50	58
550	39	72	900	50	55
650	46	72	1050	50	48
700	50	71			

## ÜBERSICHT KONVERTER / OVERVIEW CONVERTER

SEITE/PAGE		004	006	006	008	010	012	014	016	018	020	020	028	
ARTIKEL PRODUCT		AGON ROUND SQUARE	LOOK BIG ROUND	LOOK SMALL ROUND	ODIN BIG	CLAERO	COVER DITTO	PONTOS ROUND SQUARE	VINOS ROUND SQUARE	MOBILIS 250 400	ELIX MINI	ELIX	SUNRAY I	
		250mA	350mA	350mA	1050mA	700mA	140mA	250mA	350mA	700mA	350mA	350mA	250mA	
24-122204	SCHALTBAR/SWITCHABLE ON/OFF				1									
24-122413	1-10V / DALI / PUSH				1									
24-122201	SCHALTBAR/SWITCHABLE ON/OFF	1-2	1-2	1		1	1	1	1	1-2	1-2	1-2	1	
24-123400	1-10V / PUSH	1-2	1-2	1		1	1		1	1-2	1-2	1-2		
24-123403	DALI	1-2	1-2	1		1	1	1	1	1-2	1-2	1-2	1	
24-122360	SCHALTBAR/SWITCHABLE ON/OFF													
24-122203	SCHALTBAR/SWITCHABLE ON/OFF													
24-123401	1-10V / PUSH													
24-123395	DALI													
24-122815	SCHALTBAR/SWITCHABLE ON/OFF													
75-mp4	SCHALTBAR/SWITCHABLE ON/OFF													
24-122812	SCHALTBAR/SWITCHABLE ON/OFF													
24-122598	SCHALTBAR/SWITCHABLE ON/OFF													
24-123399	1-10V / PUSH							1					1	

	028	028	030/032	030/032	030/032	034	034	034	036	038	038	040
	SUNRAY II	SUNRAY III	MOON 110 ROUND SQUARE	MOON 180 ROUND SQUARE	MOON 300 ROUND SQUARE	WINDOW I	WINDOW II	PAN	IVY ROUND SQUARE	CITI Z	CIRCINO	CHICCO ROUND SQUARE
	500mA	350mA	250mA	450mA	700mA	250mA	250mA	250mA	200mA	350mA	700mA	350mA
		1										
		1										
	1		1-2	1	1	1-6	1-6	1-6		1	1	1-2
	1				1	1-6	1-6	1-6		1	1	1-2
	1		1	1	1					1	1	1-2
									1			
									1 (180mA)			
									1 (180mA)			
			1 SURFACE HOUSING			1	1	1			1	
												1
			1-2	1		1-6	1-6	1-6				

Art.Nr. / Code	page
24-122201	124
24-122203	124
24-122204	124
24-122598	124
24-122812	124
24-122815	124
24-122360	124
24-123395	125
24-123400	125
24-123401	125
24-123403	125
24-122413	125
75-mpl4	124
263-1030b	110
263-1030bal	110
263-1030s	110
263-1030sal	110
263-1040b	110
263-1040bal	110
263-1040s	110
263-1040sal	110
263-3030b	110
263-3030bal	110
263-3030bp	110
263-3030s	110
263-3030sal	110
263-3030sp	110
263-3040b	110
263-3040bal	110
263-3040bp	110
263-3040s	110
263-3040sal	110
263-3040sp	110
263-5030b	110

Art.Nr. / Code	page
263-5030bal	110
263-5030s	110
263-5030sal	110
263-5040b	110
263-5040bal	110
263-5040s	110
263-5040sal	110
273-1000s	118
276-0010990332706	020
276-0010990332756	020
276-0010990333006	020
276-0010990333056	020
276-0021590402705tr	054
276-0021590402706tr	054
276-0021590403005tr	054
276-0021590403006tr	054
276-0061290333006	060
276-0061290333056	060
276-0072190333006	060
276-0072190333056	060
276-0091190003005	046
276-0091190003063	046
276-0103090402705tr	054
276-0103090402706tr	054
276-0103090403005tr	054
276-0103090403006tr	054
276-0111190502705tr	056
276-0111190502706tr	056
276-0111190503005tr	056
276-0111190503006tr	056
276-0122190502705tr	056
276-0122190502706tr	056
276-0122190503005tr	056
276-0122190503006tr	056

Art.Nr. / Code	page
276-0130690342706	020
276-0130690342756	020
276-0130690343006	020
276-0130690343056	020
276-0141090002705tr	068
276-0141090002706tr	068
276-0141090002763tr	068
276-0141090003005tr	068
276-0141090003006tr	068
276-0141090003063tr	068
276-0151090402705tr	066
276-0151090402706tr	066
276-0151090402763tr	066
276-0161490002705tr	068
276-0161490002763tr	068
276-0161490003005tr	068
276-0161490003063tr	068
276-1002	020
276-10073080bb	018
276-10073080wb	018
276-10083080bb	018
276-10083080wb	018
276-7000	020
276-7001	020
276-7002	020
276-7003	020
276-7004	054
276-7005	054
276-7006	054
276-7007	056
276-7008	056
276-7009	056
276-7010	054
276-7011	054



Art.Nr. / Code	page
276-7012	056
276-7013	056
305-0040680202705	004
305-0040680202706	004
305-0040680202715	004
305-0040680203005	004
305-0040680203006	004
305-0040680203015	004
305-0040680402705	004
305-0040680402706	004
305-0040680402715	004
305-0040680403005	004
305-0040680403006	004
305-0040680403015	004
305-0050680202705	004
305-0050680202706	004
305-0050680202715	004
305-0050680203005	004
305-0050680203006	004
305-0050680203015	004
305-0050680402705	004
305-0050680402706	004
305-0050680402715	004
305-0050680403005	004
305-0050680403006	004
305-0050680403015	004
305-0130380003004	034
305-0130380003005	034
305-1440b	024
305-1440s	024
305-1440w	024
305-5058	034
305-602024b	014
305-602024b27k	014

Art.Nr. / Code	page
305-602024s	014
305-602024s27k	014
305-602024w	014
305-602024w27k	014
305-602427b	044
305-602427w	044
305-602430b	044
305-602430w	044
305-602527b	044
305-602527w	044
305-602530b	044
305-602530w	044
305-604427bddd	044
305-604427wddd	044
305-604430bddd	044
305-604430wddd	044
305-604527bddd	044
305-604527wddd	044
305-604530bddd	044
305-604530wddd	044
305-621524b	014
305-621524b27k	014
305-621524s	014
305-621524s27k	014
305-621524w	014
305-621524w27k	014
305-6800p	034
305-6801p	034
305-6845s	012
305-6845w	012
305-6846s	012
305-6846w	012
308-0010790302704	040
308-0010790302705	040

Art.Nr. / Code	page
308-0010790302706	040
308-0010790303004	040
308-0010790303005	040
308-0010790303006	040
308-0020790302704	040
308-0020790302705	040
308-0020790302706	040
308-0020790303004	040
308-0020790303005	040
308-0020790303006	040
308-101512337ng1	038
308-101612337ng1	038
332-1001	024
332-1202	024
332-1302	012
332-1402	012
341-0000880503004	112
341-0000880503011	112
341-0011080503011	114
341-0021580003004	112
341-0021580003011	112
341-0031580003004	112
341-0031580003011	112
341-7000	114
341-7001	114
365-0051590243005	038
365-0051590243006	038
365-0051590243014	038
365-0061590243005	010
365-0061590243006	010
365-0141390382705	016
365-0141390382706	016
365-0141390383005	016
365-0141390383006	016

Art.Nr. / Code	page
365-1001	008
365-1002b	084
365-1002w	084
365-1003132738	016
365-100313338	016
365-1003b	082
365-1003w	082
365-1004b	082
365-1004w	082
365-1005132738	016
365-100513338	016
365-1005b	082
365-1005w	082
365-1006132738	016
365-100613338	016
365-1006b	078
365-1006w	078
365-1007b	078
365-1007w	078
365-300803325ng2	076
392-0000680003005	032
392-0000680004005	032
392-0011280003005	032
392-0011280004005	032
392-0021880003005	032
392-0021880004005	032
392-0030680003005	030
392-0030680004005	030
392-0041280003005	030
392-0041280004005	030
392-0051880003005	030
392-0051880004005	030
472-0000790002704	072
472-0000790002705	072

Art.Nr. / Code	page
472-0000790002706	072
472-0000790002714	072
472-0000790002763	072
472-0000790003004	072
472-0000790003005	072
472-0000790003006	072
472-0000790003014	072
472-0000790003063	072
472-0030990003004	096
472-0030990003005	096
472-0050890003004	094
472-0050890003005	094
472-0050890003011	094
472-0060890003004	094
472-0060890003005	094
472-0060890003011	094
472-0080490003005	064
472-0080490003006	064
472-0090890003005	064
472-0090890003006	064
472-0101090382706	042
472-0101090382756	042
472-0101090382763	042
472-0101090383006	042
472-0101090383056	042
472-0101090383063	042
472-0111090382706	042
472-0111090382756	042
472-0111090382763	042
472-0111090383006	042
472-0111090383056	042
472-0111090383063	042
472-0121090002705	048
472-0121090002706	048

Art.Nr. / Code	page
472-0121090002763	048
472-0121090003005	048
472-0121090003006	048
472-0121090003063	048
472-0250480403011	114
472-0260790203005	036
472-0260790203006	036
472-0260790403005	036
472-0260790403006	036
472-0270790203005	036
472-0270790203006	036
472-0270790403005	036
472-0270790403006	036
472-0280490003004	098
472-0280490003005	098
472-0291690383006	050
472-0321090303005	006
472-0370690003005	100
472-0370690003006	100
472-0501090002704	046
472-0501090002705	046
472-0501090002706	046
472-0501090003004	046
472-0501090003005	046
472-0501090003006	046
472-0520890382707	022
472-0520890383007	022
472-0530890382705	050
472-0530890382706	050
472-0530890383005	050
472-0530890383006	050
472-0541690112705	058
472-0541690112706	058
472-0541690113005	058

Art.Nr. / Code	page
472-0541690113006	058
472-0550790002705	086
472-0550790002706	086
472-0550790003005	086
472-0550790003006	086
472-0561090003006	104
472-0561090003011	104
472-0571390003006	118
472-0571390003011	118
472-256002	102
472-256012	108
472-256075	122
472-256078	122
472-256079	122
472-258951b	052
472-258951s	052
472-258951w	052
472-258952b	052
472-258952s	052
472-258952w	052
472-25903405hv	026
472-25903406hv	026
472-259034hv	026
472-25903505hv	026
472-25903506hv	026
472-259035hv	026
472-260023	098
472-260024	098
472-260025	092
472-260026	092
472-260029	048
472-260030	048
472-260031	048
472-260032	048

Art.Nr. / Code	page
472-260042	062
472-260043	102
472-260044	102
472-260046	116
472-260047	116
472-260048wtr	080
472-260049wtr	080
472-260053btr	084
472-260053wtr	084
472-260055ag	106
472-260055s	106
472-260056ag	106
472-260056s	106
472-260056w	106
472-260057ag	116
472-260057s	116
472-29100427atr	070
472-29100427bgtr	070
472-29100427btr	070
472-29100427str	070
472-29100427wtr	070
472-29100430atr	070
472-29100430bgtr	070
472-29100430btr	070
472-29100430str	070
472-29100430wtr	070
472-291007w	066
472-291008ag	088
472-291008bgng1	088
472-291008s	088
472-291008w	088
472-291009a	074
472-291009b	074
472-291009s	074

Art.Nr. / Code	page
472-291009w	074
472-291010wr	006
472-643m21s	096
472-643m21w	096
472-645a11s	090
472-645a11w	090
472-685813c30s	120
472-686013c60s	120
643-j110agw	032
643-j180agw	032
643-j300agw	032
643-q110agw	030
643-q180agw	030
643-q300agw	030
797-0001180303005	028
797-0011880373005	028
797-0022780453005	028

Sämtliche Inhalte in diesem Katalog entsprechen dem Stand bei Drucklegung und dienen ausschließlich zu Informationszwecken. Wir behalten und das Recht vor, jederzeit und ohne Ankündigung die technischen Daten der im Katalog abgebildeten Produkte zu modifizieren. Für Farbabweichungen übernehmen wir keinerlei Haftung. Manche der im Prospekt abgebildeten Produkte sind Bildretuschen und dienen zur Veranschaulichung der Einsatzmöglichkeiten.

All details provided in the catalogue comply with available data at the time of publication, and are for information purpose only. We have the right to change/modify technical data any time without prior information. Some of the pictures are retouched and are just to show installation possibilities.

HEADQUARTERS Wels  
Office & Showroom  
4600 Wels, Austria  
Europastraße 45  
T: +43 7242 698-0  
F: +43 7242 60376  
M: office@moltoluce.com

VIENNA  
Office & Showroom  
1230 Vienna, Austria  
Vorarlberger Allee 28  
T: +43 1 6160300  
F: +43 1 6160300-40  
M: office.wien@moltoluce.com

GRAZ  
Office  
8020 Graz, Austria  
Kalvariengürtel 67  
T: +43 316 672525-0  
F: +43 316 672525-520  
M: office.graz@moltoluce.com

MUNICH  
Office & Showroom  
80807 Munich, Germany  
Walter-Gropius-Straße 23  
T: +49 89 4520565-0  
F: +49 89 4520565-20  
M: office.muenchen@moltoluce.com

COLOGNE  
Office  
51107 Cologne, Germany  
Gut Maarhausen, Eiler Straße 3v  
T: +49 221 222882-0  
F: +49 221 222882-20  
M: office.koeln@moltoluce.com

HAMBURG  
Office  
22041 Hamburg, Germany  
Wandsbeker Allee 77  
T: +49 40 2847850-1  
F: +49 40 80607299  
M: office.hamburg@moltoluce.com

[www.moltoluce.com](http://www.moltoluce.com)

MOLTO LUCE®