



new

FINISHES

ACOUSTIC COLORS



PROFILE COLORS



DIMENSIONS

LENGTHS MM.

1190

COMPONENTS

SLIM PATRICIA
SLIM LED BALL
SLIM TUBE
SLIM WALL WASHER
SLIM LENSES
SLIM MOTION LENSES
SLIM LED MODULES

POWER

STANDARD

CRI

90

COLOR TEMPERATURE

2700K | 3000K | 4000K

▼ DIMMABLE OPTIONS

DALI | 1.10

▲ LIGHT DISTRIBUTION

DOWN

LUMINAIRE INCLUDES

Suspension cables
NON-DIM DOWN: 1x Feed Hose 3 x 0,75mm²
DIM DOWN: 1x Feed Hose 5 x 0,75mm²
Cover Kit
Connection Box CB0912

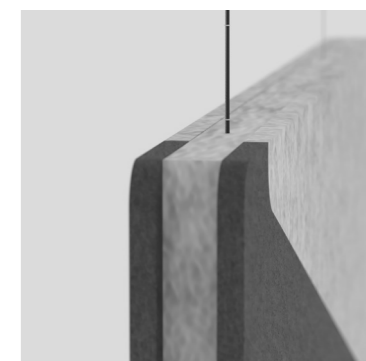
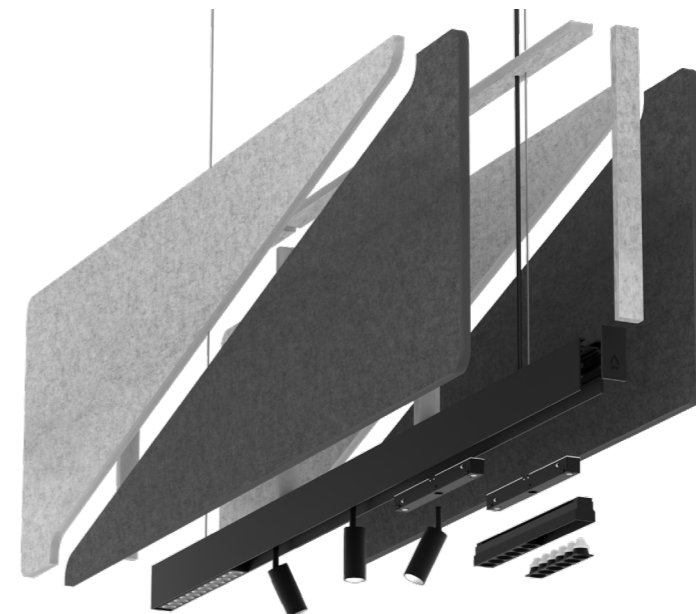

.PN

PENDANT



ACOUSTIC ALARIK SLIM

REF 230009.PN

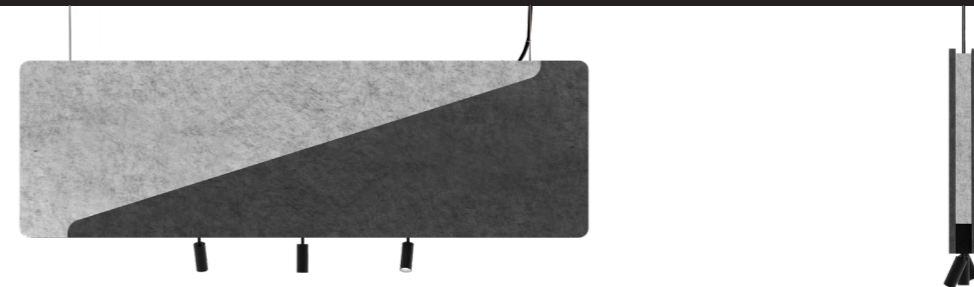

ALARIK SLIM	REF.	DIMENSION	FINISH	SKETCH
	230009	.01 1190mm.	●	

48V TRANSFORMER	DIMENSION	WATT
DR48	.01	75

Reference order | 230009.XX.PN.XX-XX-XX

Reference order | DR48.XX

SLIM PATRICIA	REF.	DIMENSION	FINISH	OPTIC OPTIONS	POWER	CRI	K	LUMEN	WATT	V _a C	DIMM	SKETCH
	11544	.01	●	.15 .38 .60	.ST	.9	.27	576	8	48	.DA .D1	
							.30	607				
							.40	695				
	11544	.02	●	.15 .38 .60	.ST	.9	.27	1173	15	48	.DA .D1	
							.30	1181				
							.40	1207				

Reference order | 11544.XX.XX.XX.ST9.XX.XX

SLIM PATRICIA ZOOM	REF.	DIMENSION	FINISH	OPTIC OPTIONS	POWER	CRI	K	LUMEN	WATT	V _a C	DIMM	SKETCH
	11546	.01	●	.15-36 .36-60	.ST	.9	.27	2038	25	48	.DA .D1	
							.30	2254				
							.40	2320				

Reference order | 11546.XX.XX.XX.ST9.XX.XX

SLIM LED BALL	REF.	DIMENSION	FINISH	OPTIC OPTIONS	POWER	CRI	K	LUMEN	WATT	V _a C	DIMM	SKETCH
	11551	.01	.BK-BK .WH-WH	.37	.ST	.9	.27	760	8	48	.DA .D1	
							.30	808				
							.40	848				

Reference order | 11551.XX.XX.XX.ST9.XX.XX

SLIM LED TUBE	REF.	DIMENSION	FINISH	OPTIC OPTIONS	POWER	CRI	K	LUMEN	WATT	V _a C	DIMM	SKETCH
	11552	.01 Ø40 x 40	●	.20 .40	.ST	.9	.27	808	14	48	.DA .D1	
							.30	820				
							.40	881				
	11552	.02 Ø60 x 60	●	.20 .40	.ST	.9	.27	1662	21	48	.DA .D1	
							.30	1716				
							.40	1729				

Reference order | 11552XX.XX.XX.ST9.XX.XX

SLIM WALL WASHER	REF.	DIMENSION	FINISH	OPTIC OPTIONS	POWER	CRI	K	LUMEN	WATT	V _a C	DIMM	SKETCH
	11550	.01	.BK-BK	-	.ST	.9	.27	1100	15	48	.DA .D1	
							.30	1169				
							.40	1251				

Reference order | 11550.XX.XX.XX.ST9.XX.XX

SLIM LENSES	REF.	DIMENSION	FINISH	OPTIC OPTIONS	POWER	CRI	K	LUMEN	WATT	V _a C	DIMM	SKETCH
	11548	.01	.BK-BK	.15 .38	.ST	.9	.27	660	8	48	.DA .D1	
							.30	750				
							.40	827				
	11548	.02	.BK-BK	.15 .38	.ST	.9	.27	1320	15	48	.DA .D1	
							.30	1511				
							.40	1654				

Reference order | 11548.XX.XX.XX.ST9.XX.XX

Select Acoustic finishes

Select Profile finishes

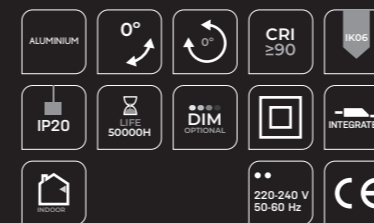
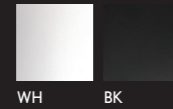

ACOUSTIC ALARIK SLIM

REF 230009.PN

PHOTOMETRY

PATRICIA

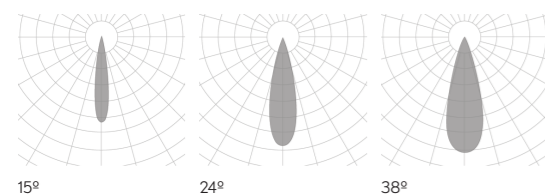

15° 24° 38°

PHOTOMETRY

LENSES

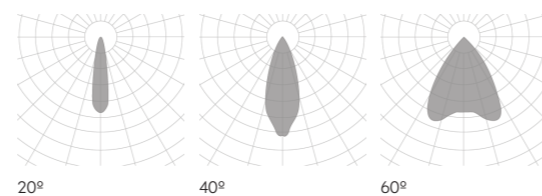

20° 40° 60°

PHOTOMETRY

LED MODULES

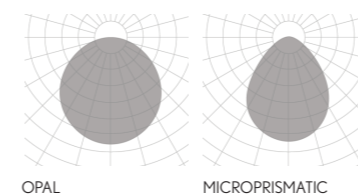

OPAL MICROPRISMATIC

INCLUDED

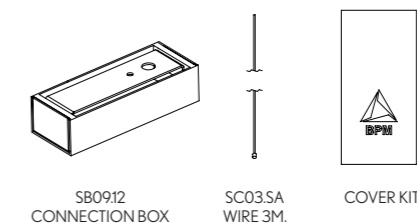

PROFILE

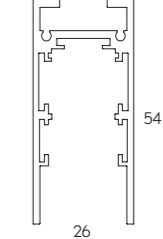

PENDANT



SLIM MOTION LENSES	REF.	DIMENSION ▲	FINISH ●	OPTIC OPTIONS ■	POWER	CRI	K	LUMEN	WATT	V _a C	DIMM ▼	SKETCH
	11547	.06	.BK-BK	.15 .38	.ST	.9	.27	660	8	48	.DA .D1	
							.30	750				
							.40	827				

Reference order | 11547.XX.XX.XX.ST9.XX.XX

SLIM LED MODULES	REF.	DIMENSION ▲	FINISH ●	DIFFUSER ■	POWER	CRI	K	LUMEN	WATT	V _a C	DIMM ▼	SKETCH
	11549	.01	.BK-BK	.OP	.ST	.9	.27	558	9	48	.DA .D1	
							.30	560				
							.40	604				
	11549	.02	.BK-BK	.OP	.ST	.9	.27	1115	18	48	.DA .D1	
							.30	1120				
							.40	1208				
	11549	.03	.BK-BK	.OP	.ST	.9	.27	1670	24	48	.DA .D1	
							.30	1680				
							.40	1812				

Reference order | 11549.XX.XX.XX.ST9.XX.XX

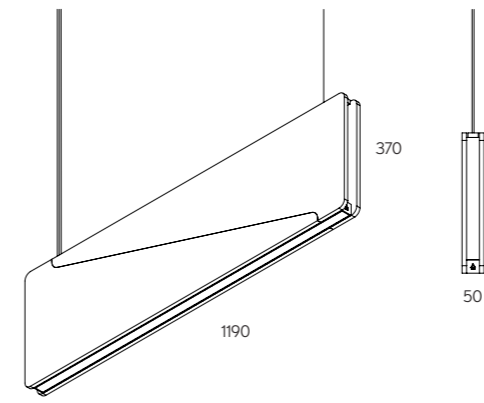

• Select Acoustic finishes • Select Profile finishes



- ALUMINIUM
- 0°
- 0°
- CRI ≥ 90
- IK06
- IP20
- LIFE 50000H
- DIM ORIGINAL
- INTEGRATED
- INDOOR
- 48V. REMOTE
- 220-240 V 50-60 Hz
- CE

ACOUSTIC ALARIK SLIM

REF 230009.PN

ACOUSTIC PROPERTIES

ENVIRONMENTAL:	Comply with the requirements detailed in the BREEAM International, BREEAM-NOR v6.0 and LEED v4.1. Standards
FIRE TEST:	Classification B-s1, d0 and CTEDB-SI Compliant
BAFFLE THICKNESS:	190 Kg/m ³
BABBLE DENSITY:	12mm
SOUND ABSORPTION COEFFICIENT:	0,92 αw

PHOTOMETRY

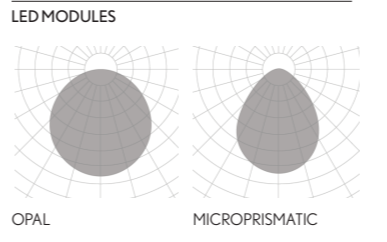

INCLUDED

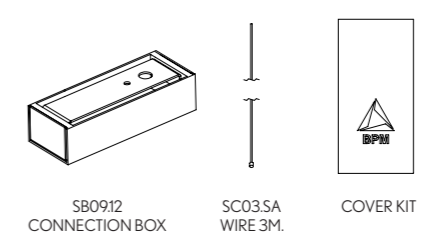

PROFILE

